



OPERATING INSTRUCTIONS

EN



FOR SALES AND SERVICE PLEASE CALL:

PTB SALES T :: 626.334.0500
sales@ptbsales.com
service@ptbsales.com
www.ptbsales.com

DATE SERVICED: _____

VIEW OUR INVENTORY

Translation of the Original

TC 400

Electronic drive unit

Dear Customer,

Thank you for choosing a Pfeiffer Vacuum product. Your new turbopump is designed to support you by its performance, its perfect operation and without interfering your individual application. The name Pfeiffer Vacuum stands for high-quality vacuum technology, a comprehensive and complete range of top-quality products and first-class service. With this expertise, we have acquired a multitude of skills contributing to an efficient and secure implementation of our product.

Knowing that our product must not interfere with your actual work, we are convinced that our product offers you the solution that supports you in the effective and trouble-free execution of your individual application.

Please read these operating instructions before putting your product into operation for the first time. If you have any questions or suggestions, please feel free to contact info@pfeiffer-vacuum.de.

Further operating instructions from Pfeiffer Vacuum can be found in the [Download Center](#) on our website.

Disclaimer of liability

These operating instructions describe all models and variants of your product. Note that your product may not be equipped with all features described in this document. Pfeiffer Vacuum constantly adapts its products to the latest state of the art without prior notice. Please take into account that online operating instructions can deviate from the printed operating instructions supplied with your product.

Furthermore, Pfeiffer Vacuum assumes no responsibility or liability for damage resulting from the use of the product that contradicts its proper use or is explicitly defined as foreseeable misuse.

Copyright

This document is the intellectual property of Pfeiffer Vacuum and all contents of this document are protected by copyright. They may not be copied, altered, reproduced or published without the prior written permission of Pfeiffer Vacuum.

We reserve the right to make changes to the technical data and information in this document.

Table of contents

1	About this manual	7
	1.1 Validity	7
	1.2 Applicable documents	7
	1.3 Target group	7
	1.4 Conventions	7
	1.4.1 Instructions in the text	7
	1.4.2 Pictographs	7
	1.4.3 Stickers on the product	8
	1.4.4 Abbreviations	8
2	Safety	9
	2.1 General safety information	9
	2.2 Safety instructions	9
	2.3 Safety precautions	10
	2.4 Limits of use of the product	11
	2.5 Proper use	11
	2.6 Foreseeable improper use	11
	2.7 Functional safety	11
3	Product description	13
	3.1 Identifying the product	13
	3.2 Product features	13
	3.3 Function	13
	3.4 Scope of delivery	13
	3.5 Connections	14
4	Installation	15
	4.1 Connection diagram	15
	4.2 "remote" connection	16
	4.2.1 Voltage supply	17
	4.2.2 Inputs	18
	4.2.3 Outputs	19
	4.2.4 Relay contacts (invertible)	19
	4.2.5 RS-485	19
5	Interfaces	20
	5.1 Interface RS-485	20
	5.1.1 Connection options	20
	5.1.2 Cross-linked via the RS-485 connection	21
	5.2 Pfeiffer Vacuum protocol for RS-485 interface	21
	5.2.1 Telegram frame	21
	5.2.2 Telegram description	22
	5.2.3 Telegram example 1	22
	5.2.4 Telegram example 2	22
	5.2.5 Data types	23
6	Parameter set	24
	6.1 General	24
	6.2 Control commands	24
	6.3 Status requests	27
	6.4 Set value settings	28
	6.5 Additional parameter for the DCU	29
7	Operation	30
	7.1 Configuring the connections with the Pfeiffer Vacuum parameter set	30
	7.1.1 Configuring the digital inputs	30
	7.1.2 Configuring digital outputs and relays	30

7.1.3	Configuring the analog input	31
7.1.4	Configuring the analog output	31
7.1.5	Configuring the accessory connections	31
7.1.6	Select interfaces	32
7.2	Operating modes	32
7.2.1	Gas type-dependent operation	32
7.2.2	Set value power consumption	33
7.2.3	Run-up time	33
7.2.4	Rotation speed switch points	34
7.2.5	Rotation speed setting mode	35
7.2.6	Standby	35
7.2.7	Confirming the speed specification	36
7.2.8	Backing pump operating modes	36
7.2.9	Backing pump standby mode	37
7.2.10	Operation with accessories	37
7.2.11	Venting modes	38
7.3	Switching on the turbopump	38
7.4	Switching off the turbopump	39
7.5	Operation monitoring	39
7.5.1	Operating mode display via LED	39
7.5.2	Temperature monitoring	39
8	Recycling and disposal	40
8.1	General disposal information	40
8.2	Dispose of electronic drive unit	40
9	Malfunctions	41
9.1	General	41
9.2	Error codes	41
9.3	Warning and error messages when operating with DCU	44
10	Service solutions by Pfeiffer Vacuum	45
	Declaration of conformity	47

List of tables

Tbl. 1:	Stickers on the product	8
Tbl. 2:	Abbreviations used in this document	8
Tbl. 3:	Permissible ambient conditions	11
Tbl. 4:	Data for use in safety-related applications in accordance with IEC 61508 and IEC 62061	11
Tbl. 5:	Data for use in safety-related applications in accordance with EN ISO 13849-1	12
Tbl. 6:	Features of the device variants	13
Tbl. 7:	Connection description of the electronic drive unit	14
Tbl. 8:	Terminal layout of 26-pin "remote" connection	17
Tbl. 9:	Features of the RS-485 interface	20
Tbl. 10:	Terminal layout of the RS-485 connecting socket M12	20
Tbl. 11:	Explanation and meaning of the parameters	24
Tbl. 12:	Control commands	27
Tbl. 13:	Status requests	28
Tbl. 14:	Set value settings	29
Tbl. 15:	Parameter for DCU functions	29
Tbl. 16:	Configuring parameters [P:062], [P:063] and [P:064]	30
Tbl. 17:	Configuring parameters [P:019] and [P:024], or [P:045], [P:046], [P:047] and [P:028]	31
Tbl. 18:	Configuring parameter [P:057]	31
Tbl. 19:	Configuring parameter [P:055]	31
Tbl. 20:	Accessory connections	32
Tbl. 21:	Parameter [P:060]	32
Tbl. 22:	Characteristic nominal rotation speeds of the turbopumps	36
Tbl. 23:	Backing pump operating modes	36
Tbl. 24:	Behavior and meaning of the LEDs on the electronic drive unit	39
Tbl. 25:	Error messages of the electronic drive unit	43
Tbl. 26:	Warning messages of the electronic drive unit	44
Tbl. 27:	Warning and error messages when using a DCU	44

List of figures

Fig. 1:	Standard panel TC 400	13
Fig. 2:	Connection diagram for the electronic drive unit. Example: external circuit for "remote"	16
Fig. 3:	Rotation speed setting mode pin 7 and pin 11	19
Fig. 4:	Connection options via interface RS-485	20
Fig. 5:	Networking of turbopumps with integrated electronic drive unit via interface RS-485	21
Fig. 6:	Schematic diagram of power characteristics, example of heavy gases [P:027] = 0	33
Fig. 7:	Rotation speed switch point 1 active	34
Fig. 8:	Rotation speed switch points 1 & 2 active, [P:701] > [P:719]	34
Fig. 9:	Rotation speed switch points 1 & 2 active, [P:701] < [P:719]	35

1 About this manual



IMPORTANT

Read carefully before use.
Keep the manual for future consultation.

1.1 Validity

This operating instructions is a customer document of Pfeiffer Vacuum. The operating instructions describe the functions of the named product and provide the most important information for the safe use of the device. The description is written in accordance with the valid directives. The information in this operating instructions refers to the product's current development status. The document shall remain valid provided that the customer does not make any changes to the product.

1.2 Applicable documents

TC 400	Operating instructions
Declaration of conformity	A component of these instructions

1.3 Target group

These operating instructions are aimed at all persons performing the following activities on the product:

- Transportation
- Setup (Installation)
- Usage and operation
- Decommissioning
- Maintenance and cleaning
- Storage or disposal

The work described in this document is only permitted to be performed by persons with the appropriate technical qualifications (expert personnel) or who have received the relevant training from Pfeiffer Vacuum.

1.4 Conventions

1.4.1 Instructions in the text

Usage instructions in the document follow a general structure that is complete in itself. The required action is indicated by an individual step or multi-part action steps.

Individual action step

A horizontal, solid triangle indicates the only step in an action.

- ▶ This is an individual action step.

Sequence of multi-part action steps

The numerical list indicates an action with multiple necessary steps.

1. Step 1
2. Step 2
3. ...

1.4.2 Pictographs

Pictographs used in the document indicate useful information.



Note



Tip

1.4.3 Stickers on the product

This section describes all the stickers on the product along with their meaning.

	<p>Rating plate The rating plate is located on the side of the electronic drive unit.</p>
	<p>Closure seal The product is sealed ex-factory. Damaging or removing a closure seal results in loss of the warranty.</p>

Tbl. 1: Stickers on the product

1.4.4 Abbreviations

Abbreviation	Meaning in this document
AI/AO	Analog Input/Analog Output
AIC	Ampere Interrupting Capacity
DC	Direct Current
DCU	Display Control Unit from Pfeiffer Vacuum
DI/DO	Digital Input/Digital Output
f	Rotation speed value of a vacuum pump (frequency, in rpm or Hz)
HPU	Handheld Programming Unit, aid for controlling and monitoring parameters
I	Electric amperage
LED	Light Emitting Diode
[P:xxx]	Electronic drive unit control parameters. Printed in bold as a three-digit number in square brackets. Frequently displayed in conjunction with a short description Example: [P:312] software version
P	Electrical Power
PE	Protective Earth
R	Electrical Resistance
remote	26-pole D-Sub connecting socket on the turbopump electronic drive unit
RS-485	Standard for a physical interface for asynchronous serial data transmission (Recommended Standard)
t	Time
TC	Electronic drive unit (Turbo Controller)
TMS	Temperature Management System
U	Electric voltage

Tbl. 2: Abbreviations used in this document

2 Safety

2.1 General safety information

The following 4 risk levels and 1 information level are taken into account in this document.

DANGER

Immediately pending danger

Indicates an immediately pending danger that will result in death or serious injury if not observed.

- ▶ Instructions to avoid the danger situation

WARNING

Potential pending danger

Indicates a pending danger that could result in death or serious injury if not observed.

- ▶ Instructions to avoid the danger situation

CAUTION

Potential pending danger

Indicates a pending danger that could result in minor injuries if not observed.

- ▶ Instructions to avoid the danger situation

NOTICE

Danger of damage to property

Is used to highlight actions that are not associated with personal injury.

- ▶ Instructions to avoid damage to property



Notes, tips or examples indicate important information about the product or about this document.

2.2 Safety instructions

All safety instructions in this document are based on the results of the risk assessment carried out in accordance with Low Voltage Directive 2014/35/EU. Where applicable, all life cycle phases of the product were taken into account.

Risks during installation

DANGER

Danger to life from electric shock

Power supply packs that are not specified or are not approved will lead to severe injury to death.

- ▶ Make sure that the power supply pack meets the requirements for double isolation between mains input voltage and output voltage, in accordance with IEC 61010-1 IEC 60950-1 and IEC 62368-1.
- ▶ Make sure that the power supply pack meets the requirements in accordance with IEC 61010-1 IEC 60950-1 and IEC 62368-1.
- ▶ Where possible, use original power supply packs or only power supply packs that correspond with the applicable safety regulations.

⚠ DANGER

Danger to life from electric shock

When establishing the voltages that exceed the specified safety extra-low voltage (according to IEC 60449 and VDE 0100), the insulating measures will be destroyed. There is a danger to life from electric shock at the communication interfaces.

- ▶ Connect only suitable devices to the bus system.

⚠ WARNING

Risk of injury due to incorrect installation

Dangerous situations may arise from unsafe or incorrect installation.

- ▶ Do not carry out your own conversions or modifications on the unit.
- ▶ Ensure the integration into an Emergency Off safety circuit.

Risks in the event of malfunctions

⚠ WARNING

Risk of injury from parts moving after a power failure or troubleshooting

The "pumping station" function of the electronic drive unit will remain active after a power failure or if errors occur that shut down the vacuum pump or the system. When power is restored or after acknowledging a fault, the vacuum pump runs up automatically. There is a risk of injury to fingers and hands if they enter the operating range of rotating parts.

- ▶ Always keep the mains connection freely accessible so you can disconnect it at any time.
- ▶ Remove present mating plugs or bridges from the electronic drive unit possibly before the mains power returns, as these can cause an automatic run-up.
- ▶ Switch the pump off using the "Pumping station" function (parameter **[P:010]**).

2.3 Safety precautions



Duty to provide information on potential dangers

The product holder or user is obliged to make all operating personnel aware of dangers posed by this product.

Every person who is involved in the installation, operation or maintenance of the product must read, understand and adhere to the safety-related parts of this document.



Infringement of conformity due to modifications to the product

The Declaration of Conformity from the manufacturer is no longer valid if the operator changes the original product or installs additional equipment.

- Following the installation into a system, the operator is required to check and re-evaluate the conformity of the overall system in the context of the relevant European Directives, before commissioning that system.

General safety precautions when handling the product

- ▶ Use only power supply packs that comply with the applicable safety regulations.
- ▶ Observe all applicable safety and accident prevention regulations.
- ▶ Check that all safety measures are observed at regular intervals.
- ▶ Recommendation: Establish a secure connection to the earthed conductor (PE); protection class III.
- ▶ Never disconnect plug connections during operation.
- ▶ Keep lines and cables away from hot surfaces (> 70 °C).
- ▶ Do not carry out your own conversions or modifications on the unit.
- ▶ Observe the unit protection class prior to installation or operation in other environments.
- ▶ Observe the protection class by ensuring the correct seating of the present sealing plugs.
- ▶ Disconnect the electronic drive unit only once everything has come to a complete standstill and when the mains power supply of the turbopump is interrupted.

2.4 Limits of use of the product

Installation location	weatherproof (internal space)
Air pressure	750 hPa to 1060 hPa
Installation altitude	max. 5000 m
Rel. air humidity	max. 80 %, at $T \leq 31 \text{ }^\circ\text{C}$, up to max. 50% at $T \leq 40 \text{ }^\circ\text{C}$
Protection class	III
Excess voltage category	II
Permissible protection degree	IP54
Degree of contamination	2
Ambient temperature	+5 °C to +40 °C

Tbl. 3: Permissible ambient conditions



Notes on ambient conditions

The specified permissible ambient temperatures apply to operation of the turbopump at maximum permissible backing pressure or at maximum gas throughput, depending on the cooling type. The turbopump is intrinsically safe thanks to redundant temperature monitoring.

- The reduction in backing pressure or gas throughput permits operation of the turbopump at higher ambient temperatures.
- If the maximum permissible operating temperature of the turbopump is exceeded, the electronic drive unit first reduces the drive output and then switches it off where necessary.

2.5 Proper use

- The electronic drive unit is used exclusively for the operation of Pfeiffer Vacuum turbopumps and their accessories.

2.6 Foreseeable improper use

Improper use of the product invalidates all warranty and liability claims. Any use that is counter to the purpose of the product, whether intentional or unintentional, is regarded as misuse, in particular:

- Connection to power supplies that do not comply with the provisions of IEC 61010 or IEC 60950
- Operation with excessively high irradiated heat output
- Use in areas with ionizing radiation
- Operation in explosion-hazard areas
- Use of accessories or spare parts that are not listed in these instructions

2.7 Functional safety

The TC 400 drive unit (electronic drive unit) executes the "Safe Limited Speed" safety function in accordance with EN 61800-5-2. In the event of excess rotation speed, the vacuum pump motor's commutation switches off and brings the drive into a safe state.

Summary of characteristic data for use in safety-related applications:

Characteristics in accordance with IEC 61508 and IEC 62061				
Characteristic	Safety Integrity Level	PFH	PFD _{av}	Proof Test Interval T
Value	SIL CL 2	$1.1 \cdot 10^{-8} / \text{h}$	$1 \cdot 10^{-3}$	20 a

Tbl. 4: Data for use in safety-related applications in accordance with IEC 61508 and IEC 62061

Characteristics in accordance with EN ISO 13849-1				
Characteristic	Performance Level	Category	MTTF _d	Average diagnostic coverage DC
Value	PL d	Cat. 3	high (135 a)	Medium (90 % - < 99 %)

Tbl. 5: Data for use in safety-related applications in accordance with EN ISO 13849-1

- No proof test is required throughout the expected device lifetime of up to 20 years.
- If you calculate your safety application with the specified values for 20 years, you will need to de-commission the safety controller and return it to the manufacturer after 20 years. You must not perform a proof test.

3 Product description

3.1 Identifying the product

- ▶ To ensure clear identification of the product when communicating with Pfeiffer Vacuum, always keep all of the information on the rating plate to hand.
- ▶ Learn about certifications through test seals on the product or at www.certipedia.com with company ID no. 000021320.

3.2 Product features

The type TC 400 electronic drive unit is a permanent component of the turbopump. The purpose of the electronic drive unit is to drive, monitor and control the entire turbopump.

Feature	TC 400	
Connection voltage TC	24 V DC \pm 10 %	48 V DC \pm 10 %
Connection panel	Standard (RS-485)	Standard (RS-485)
Turbopump HiPace	300, 400, 700, 800	300, 400, 700, 800

Tbl. 6: Features of the device variants

3.3 Function

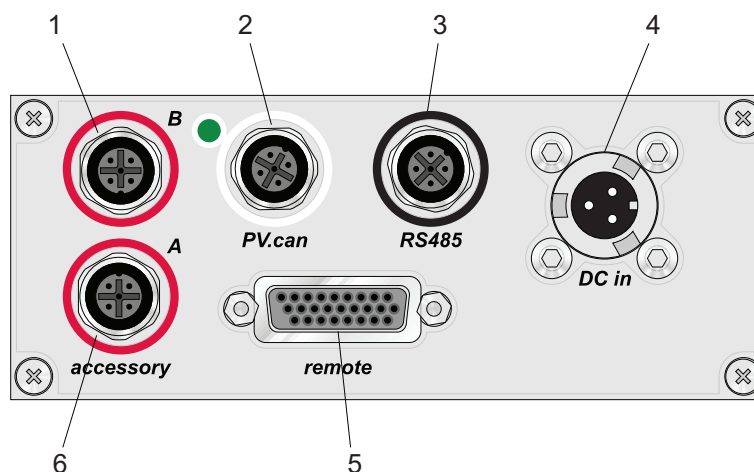







Fig. 1: Standard panel TC 400

- | | |
|-------------------------------|----------------------------|
| 1 Connection "accessory B" | 4 Connection "DC in" |
| 2 "PV.can" service connection | 5 "remote" connection |
| 3 Connection "RS-485" | 6 Connection "accessory A" |

3.4 Scope of delivery

- TC 400
- Operating instructions

3.5 Connections

	DC in¹⁾ Housing connector with bayonet lock for the voltage supply between Pfeiffer Vacuum power supply packs and the TC electronic drive unit.
	accessory M12 socket with screw lock for the connection of Pfeiffer Vacuum accessories. The use of a Y-distributor permits the double allocation of a connection.
	PV.can M12 socket with screw lock and LED for the connection of an integrated pressure measurement and for Pfeiffer Vacuum service purposes.
	remote High-density D-sub socket with 26 pins for connection and configuration of a remote control.
	RS-485 M12 socket with screw lock for the connection of Pfeiffer Vacuum control panels or PC. The use of a Y-distributor permits the integration into a bus system.
	Device socket on the rear side of the electronic drive unit for the connection of the turbopump.

Tbl. 7: Connection description of the electronic drive unit

1) "DC in" and "accessory" are described in the operating instructions of the turbopump.

4 Installation

4.1 Connection diagram

DANGER

Danger to life from electric shock

Power supply packs that are not specified or are not approved will lead to severe injury to death.

- ▶ Make sure that the power supply pack meets the requirements for double isolation between mains input voltage and output voltage, in accordance with IEC 61010-1 IEC 60950-1 and IEC 62368-1.
- ▶ Make sure that the power supply pack meets the requirements in accordance with IEC 61010-1 IEC 60950-1 and IEC 62368-1.
- ▶ Where possible, use original power supply packs or only power supply packs that correspond with the applicable safety regulations.

DANGER

Danger to life from electric shock

When establishing the voltages that exceed the specified safety extra-low voltage (according to IEC 60449 and VDE 0100), the insulating measures will be destroyed. There is a danger to life from electric shock at the communication interfaces.

- ▶ Connect only suitable devices to the bus system.

WARNING

Risk of injury due to incorrect installation

Dangerous situations may arise from unsafe or incorrect installation.

- ▶ Do not carry out your own conversions or modifications on the unit.
- ▶ Ensure the integration into an Emergency Off safety circuit.



Contact load for the accessory connections to "accessory"

1. Note the maximum contact load of 200 mA per connection.
2. However, do not exceed the total sum of the load of all connections of 450 mA.



Potential-free connections

- All inputs and outputs of the "remote" connections, "RS-485" and "PV.can" are galvanically separated from $+U_B$.
- The contacts of relays 1, 2 and 3 are potential-free.

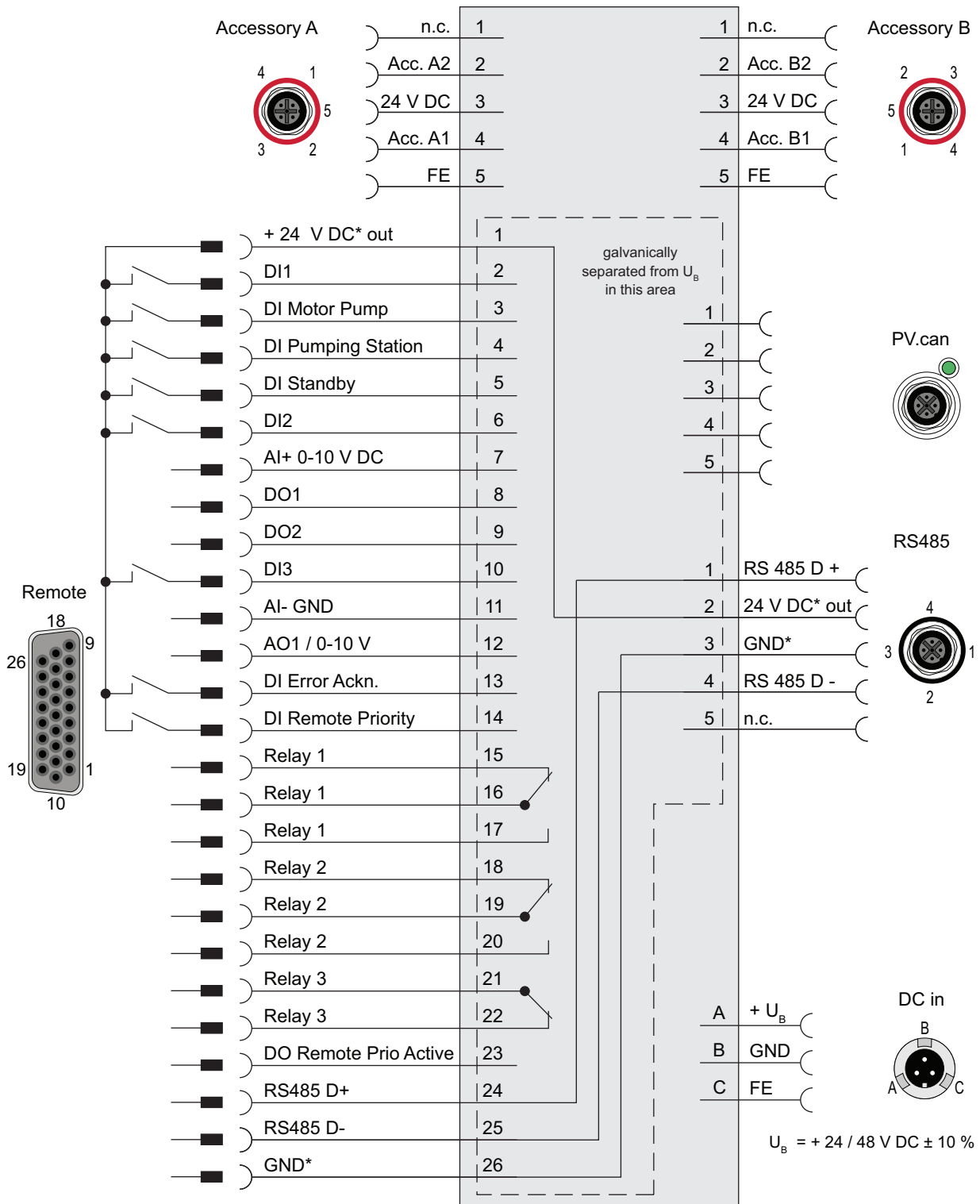
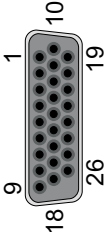

Fig. 2: Connection diagram for the electronic drive unit. Example: external circuit for "remote"

4.2 "remote" connection

The 26-pin D-sub connection with the "remote" designation offers the possibility to operate the electronic drive unit via remote control. The accessible individual functions are mapped to "PLC levels". The following specifications are the factory settings for the electronic drive unit. They can be configured with the Pfeiffer Vacuum parameter set.

- ▶ Remove the remote plug from the TC 400 and connect a remote control.
- ▶ Utilize the screened plug and cable.

	Pin	Assignment	Description, factory setting
	1	+24 V DC* output (V+)	Reference voltage for all digital inputs and outputs
	2	DI1	Enable venting (open: off, V+: on)
	3	DI motor vacuum pump	Drive motor (open: off; V+: on)
	4	DI pumping station	open: off; V+: on and error acknowledgment
	5	DI standby	Standby rotation speed (open: off, V+: on)
	6	DI2	Heater (open: off, V+: on)
	7	AI+ rotation speed setting mode	Setpoint in rotation speed setting mode; 2 - 10 V DC corresponds to 20 - 100% of the nominal rotation speed
	8	DO1	Speed-control switchpoint reached; GND: no, V+: yes ($I_{max} = 50 \text{ mA}/24 \text{ V}$)
	9	DO2	GND: error, V+: no error ($I_{max} = 50 \text{ mA}/24 \text{ V}$)
	10	DI3	Sealing gas (open: off, V+: on)
	11	AI rotation speed setting mode GND	Setpoint in rotation speed setting mode; GND
	12	AO1	Actual speed; 0 to 10 V DC corresponds to 0 to 100%: $R_L > 10 \text{ k}\Omega$
	13	DI error acknowledgement	Error acknowledgement: V+ pulse (min. 500 ms)
	14	DI remote priority	Operation via "remote" interface (open: off, V+: set and takes priority over other digital inputs)
	15	Relay 1	Connection with pin 16, if relay 1 inactive
	16	Relay 1	Rotation speed switchpoint reached; Relay contact 1 ($U_{max} = 50 \text{ V DC}$; $I_{max} = 1 \text{ A}$)
	17	Relay 1	Connection with pin 16, if relay 1 active
	18	Relay 2	Connection with pin 19, if relay 2 inactive
	19	Relay 2	No error; relay contact 2 ($U_{max} = 50 \text{ V DC}$; $I_{max} = 1 \text{ A}$)
	20	Relay 2	Connection with pin 19, if relay 2 active
	21	Relay 3	Connection with pin 22, if relay 3 inactive
	22	Relay 3	Warning; relay contact 3 ($U_{max} = 50 \text{ V DC}$; $I_{max} = 1 \text{ A}$)
	23	DO remote priority	GND: off, V+: remote priority active
	24	RS-485 D+	in accordance with the specification and Pfeiffer Vacuum protocol
	25	RS-485 D-	in accordance with the specification and Pfeiffer Vacuum protocol
	26	Ground (GND*)	Reference mass for all digital inputs and outputs

Tbl. 8: Terminal layout of 26-pin "remote" connection

4.2.1 Voltage supply

+24 V DC* output/pin 1

A connection with +24 V DC to pin 1 (active high) activates inputs 2 to 6, as well as the connections to pins 10, 13 and 14. Alternatively, they can be activated via an external PLC. "PLC High level" activates and "PLC Low level" deactivates the functions.

- PLC High level: +13 V to +33 V
- PLC Low level: -33 V to +7 V

- Ri: 7 kΩ
- I_{max} < 210 mA (with RS-485, where present)

4.2.2 Inputs

The digital inputs at the "remote" connection are used to switch various electronic drive unit functions. Inputs DI1 to DI2 are assigned functions in the factory. You can configure them via the RS-485 interface and the Pfeiffer Vacuum parameter set.

DI1 (release venting)/pin 2

V+: Enable venting (venting as per venting mode)

open: Venting blocked (no venting occurs)

DI motor vacuum pump/pin 3

The turbopump starts up with activation of pin 4 (pumping station) and successful self-testing of the electronic drive unit. The turbopump can be switched off and switched on again during operation with the pumping station still activated. This will not initiate a venting action.

V+: Turbo pump motor on

open: Turbo pump motor off

DI pumping station/pin 4

Control of connected pumping station components (e.g. backing pump, venting valve, air cooling) and start-up of the turbopump with simultaneously activated pin 3 (motor). Any pending error messages are reset by eliminating the cause.

V+: Error acknowledgement and pumping station on

open: Pumping station off

DI standby/pin 5

In standby mode, the turbopump operates at a specified rotor speed < nominal rotation speed. The factory setting and recommended operation is 66.7 % of the nominal rotation speed.

V+: Standby activated

open: Standby off, operation at nominal rotation speed

DI2 (heater)/pin 6

V+: Heater on

open: Heater off

DI3 (sealing gas)/pin 10

V+: Sealing gas valve open

open: Sealing gas valve closed

DI error acknowledgment/pin 13

V+: Pending error messages reset when cause has been eliminated with a pulse of min. 500 ms duration

open: Inactive

DI remote priority/pin 14

V+: The "remote" connection has control priority over all other digital inputs.

open: Remote priority inactive

AI rotation speed setting mode/pin 7 and pin 11

The analog input serves as a rotation speed setpoint for the turbopump. An input signal of 2 to 10 V between AI+ (pin 7) and GND (pin 11) corresponds to a rotation speed within the range of 20 to 100 % of the nominal rotation speed. If the input is open or signals are below 2 V, the turbopump accelerates to the nominal rotation speed.

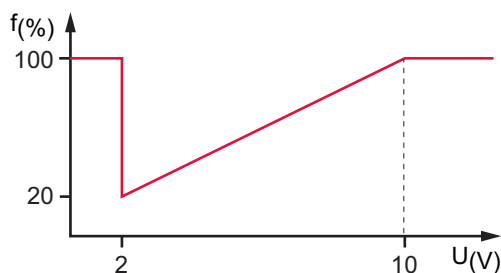

Fig. 3: Rotation speed setting mode pin 7 and pin 11

4.2.3 Outputs

The digital outputs at the "remote" connection have a maximum load limit of 24 V/50 mA per output. You can configure all outputs listed below with the Pfeiffer Vacuum parameter set via the RS-485 interface (description relates to factory settings).

DO1 (rotation speed switch point reached)/pin 8

Active high: After reaching the rotation speed switch point. Rotation speed switch point 1 has a factory setting of 80% of the nominal rotation speed. This can be used for a "Ready for operation" message, for example.

DO2 (no error)/pin 9

When the supply voltage has been connected, digital output DO2 permanently outputs 24 V DC, which means "no error". Active low: in case of error (group error message).

DO remote priority active/pin 23

Active high: The "remote" connection takes priority over all other potentially connected control units (e.g. RS-485). Active low ignores the "remote" connection.

AO1 analog output 0 to 10 V DC/pin 12

You can pick off a speed-proportional voltage (0 to 10 V DC, equals 0 to 100% × f_{Nominal}) at the analog output (load $R \geq 10 \text{ k}\Omega$). You can assign additional functions (optionally current/power) to the analog output via DCU, HPU or PC.

4.2.4 Relay contacts (invertible)

Relay 1/pins 15, 16 and 17

The contact between pin 16 and pin 15 is closed when the rotation speed drops below the switchpoint; relay 1 is inactive. The contact between pin 16 and pin 17 is closed when the speed reaches the rotation speed switchpoint; relay 1 is active.

Relay 2/pins 18, 19 and 20

The contact between pin 19 and pin 18 is closed when an error is pending; relay 2 is inactive. The contact between pin 19 and pin 20 is closed in case of trouble-free operation; relay 2 is active.

Relay 3/pins 21 and 22

The contact between pin 21 and pin 22 is closed in case of inactive warning messages; relay 3 is inactive. The contact between pin 21 and pin 22 is open when warnings are pending; relay 3 is active.

4.2.5 RS-485

Pin 24 and pin 25

You can connect a Pfeiffer Vacuum display and control unit (DCU or HPU) or an external PC via pin 24 and pin 25 at the "remote" connection of the electronic drive unit.

5 Interfaces

5.1 Interface RS-485

The interface with the designation “RS-485” is intended for the connection of a Pfeiffer Vacuum display and control unit (DCU or HPU) or an external computer. The connections are galvanically safe and are isolated from the maximum supply voltage of the electronic drive unit. The electrical connections are optically decoupled internally.

Designation	Value
Serial interface	RS-485
Baudrate	9600 Baud
Data word length	8 bit
Parity	none (no parity)
Start bits	1
Stop bits	1

Tbl. 9: Features of the RS-485 interface

	Pin	Assignment
	1	RS-485 D+
	2	+24 V output, ≤ 210 mA loading capacity
	3	GND
	4	RS-485 D-
	5	not connected

Tbl. 10: Terminal layout of the RS-485 connecting socket M12

5.1.1 Connection options

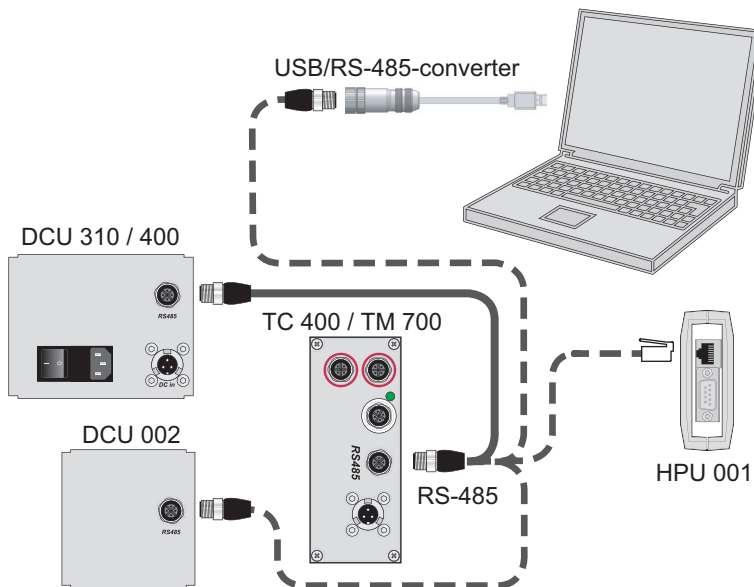

Fig. 4: Connection options via interface RS-485

Connecting Pfeiffer Vacuum display and control panels or PC

At interface RS-485, one external control panel can be connected in each case.

1. Use the respective connection cable supplied with the control panel or from the range of accessories.
2. Use the option to connect a PC via the USB/RS-485 converter.

5.1.2 Cross-linked via the RS-485 connection

⚠ DANGER

Danger to life from electric shock

When establishing the voltages that exceed the specified safety extra-low voltage (according to IEC 60449 and VDE 0100), the insulating measures will be destroyed. There is a danger to life from electric shock at the communication interfaces.

- ▶ Connect only suitable devices to the bus system.

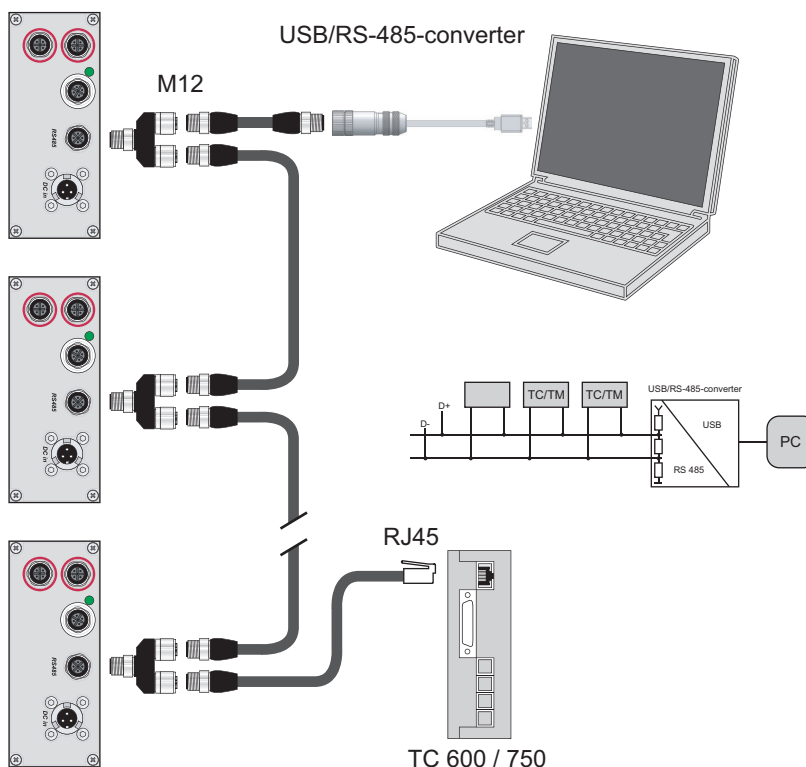

Fig. 5: Networking of turbopumps with integrated electronic drive unit via interface RS-485

Connect the peripheral devices

The group address of the electronic drive unit is 962.

1. Install the devices according to the specification for RS-485 interfaces.
2. Make sure that all devices connected to the bus have different RS-485 device addresses [**P:797**].
3. Connect all devices to the bus with RS-485 D+ and RS-485 D-.

5.2 Pfeiffer Vacuum protocol for RS-485 interface

5.2.1 Telegram frame

The telegram frame of the Pfeiffer Vacuum protocol contains only ASCII code characters [32; 127], the exception being the end character of the telegram C_R . Basically, a master (e.g. a PC) sends a telegram, which is answered by a slave (e.g. electronic drive unit or transmitter).

a2	a1	a0	*	0	n2	n1	n0	l1	l0	dn	...	d0	c2	c1	c0	C_R
a2 – a0				Unit address for slave												
				<ul style="list-style-type: none"> • Individual address of the unit ["001";"255"] • Group address "9xx" for all identical units (no response) • global address "000" for all units on the bus (no response) 												
*				Action according to telegram description												
n2 – n0				Pfeiffer Vacuum parameter numbers												

l1 – l0	Data length dn to d0
dn – d0	Data in the respective data type (see chapter “Data types”, page 23).
c2 – c0	Checksum (sum of ASCII values of cells a2 to d0) modulo 256
C _R	carriage return (ASCII 13)

5.2.2 Telegram description

Data query --> ?

a2	a1	a0	0	0	n2	n1	n0	0	2	=	?	c2	c1	c0	C _R
----	----	----	---	---	----	----	----	---	---	---	---	----	----	----	----------------

Control command --> !

a2	a1	a0	1	0	n2	n1	n0	l1	l0	dn	...	d0	c2	c1	c0	C _R
----	----	----	---	---	----	----	----	----	----	----	-----	----	----	----	----	----------------

Data response / Control command understood -->

a2	a1	a0	1	0	n2	n1	n0	l1	l0	dn	...	d0	c2	c1	c0	C _R
----	----	----	---	---	----	----	----	----	----	----	-----	----	----	----	----	----------------

Error message -->

a2	a1	a0	1	0	n2	n1	n0	0	6	N	O	_	D	E	F	c2	c1	c0	C _R
										_	R	A	N	G	E				
										_	L	O	G	I	C				

- NO_DEF Parameter number n2–n0 no longer exists
- _RANGE Data dn–d0 outside the permissible range
- _LOGIC Logical access error

5.2.3 Telegram example 1

Data query

Current rotation speed (parameter **[P:309]**, device address slave: "123")

--> ?	1	2	3	0	0	3	0	9	0	2	=	?	1	1	2	C _R
ASCII	49	50	51	48	48	51	48	57	48	50	61	63	49	49	50	13

Data response: 633 Hz

Current rotation speed (parameter **[P:309]**, device address Slave: "123")

-->	1	2	3	1	0	3	0	9	0	6	0	0	0	6	3	3	0	3	7	C _R
ASCII	49	50	51	49	48	51	48	57	48	54	48	48	48	54	51	51	48	51	55	13

5.2.4 Telegram example 2

Control command

Switch on the pumping station (parameter **[P:010]**, device address Slave: "042")

--> !	0	4	2	1	0	0	1	0	0	6	1	1	1	1	1	1	0	2	0	C _R
ASCII	48	52	50	49	48	48	49	48	48	54	49	49	49	49	49	49	48	50	48	13

Control command understood

Switch on the pumping station (parameter **[P:010]**, device address Slave: "042")

-->	0	4	2	1	0	0	1	0	0	6	1	1	1	1	1	1	0	2	0	C _R
ASCII	48	52	50	49	48	48	49	48	48	54	49	49	49	49	49	49	48	50	48	13

5.2.5 Data types

No.	Data type	Description	Length l1 – l0	Example
0	boolean_old	Logical value (false/true)	06	000000 corresponds with false 111111 corresponds with true
1	u_integer	Positive whole number	06	000000 to 999999
2	u_real	Positive fixed point number	06	001571 corresponds with 15.71
3	u_expo	Positive exponential number	06	1.2E-2 corresponds with $1,2 \cdot 10^{-2}$ 005E8 corresponds with $5 \cdot 10^8$
4	string	Any character string with 6 characters. ASCII codes between 32 and 127	06	TC_110, TM_700
6	boolean_new	Logical value (false/true)	01	0 corresponds with false 1 corresponds with true
7	u_short_int	Positive whole number	03	000 to 999
10	u_expo_new	Positive exponential number. The last of both digits are the exponent with a deduction of 20.	06	100023 corresponds with $1,0 \cdot 10^3$ 100000 corresponds with $1,0 \cdot 10^{-20}$
11	string16	Any character string with 16 characters. ASCII codes between 32 and 127	16	this-is-an-example
12	string8	Any character string with 8 characters. ASCII codes between 32 and 127	08	Example

6 Parameter set

6.1 General

Important settings and function-related characteristics are factory-programmed into the electronic drive unit as parameters. Each parameter has a three-digit number and a description. The use of the parameter is possible via Pfeiffer Vacuum displays and control panels, or externally via RS-485 using Pfeiffer Vacuum protocol.

The vacuum pump starts in standard mode with factory default pre-set parameters.



Non-volatile data storage









When switching off or in the event of unintentional voltage drop, the **parameters** and the operating hours stay saved in the electronics.

#	Three digit number of the parameter
Display	Display of parameter description
Description	Brief description of the parameters
Functions	Function description of the parameters
Data type	Type of formatting of the parameter for the use with the Pfeiffer Vacuum protocol
Access type	R (read): Read access; W (write): Write access
Unit	Physical unit of the described variable
min. / max.	Permissible limit values for the entry of a value
default	Factory default pre-setting (partially pump-specific)
	The parameter can be saved non-volatile in the electronic drive unit













Tbl. 11: Explanation and meaning of the parameters







6.2 Control commands

#	Display	Description	Functions	Data type	Access type	Unit	min.	max.	de-fault	
001	Heating	Heating	0 = off 1 = on	0	RW		0	1	0	✓
002	Standby	Standby	0 = off 1 = on	0	RW		0	1	0	✓
004	RUTimeCtrl	Run-up time control	0 = off 1 = on	0	RW		0	1	1	✓
009	ErrorAckn	Error acknowledgement	1 = Error acknowledgement	0	W		1	1		
010	PumpgStatn	Pumping station	0 = off 1 = on and error acknowledgement	0	RW		0	1	0	✓
012	EnableVent	Enable venting	0 = no 1 = yes	0	RW		0	1	0	✓
017	CfgSpdSwPt	Configuration rotation speed switch point	0 = Rotation speed switch point 1 1 = Rotation speed switch points 1 & 2	7	RW		0	1	0	✓

#	Display	Description	Functions	Data type	Access type	Unit	min.	max.	de- fault	
019	Cfg DO2	Output DO2 configuration	0 = Rotation speed switch point reached 1 = No error 2 = Error 3 = Warning 4 = Error and/or warning 5 = Set rotation speed reached 6 = Pump on 7 = Pump accelerating 8 = Pump decelerating 9 = Always "0" 10 = Always "1" 11 = Remote priority active 12 = Heating 13 = Backing pump 14 = Sealing gas 15 = Pumping station 16 = Pump rotates 17 = Pump does not rotate 19 = Pressure switch point 1 underrun 20 = Pressure switch point 2 underrun 21 = Fore-vacuum valve, delayed 22 = Backing pump stand-by	7	RW		0	22	1	
023	MotorPump	Motor vacuum pump	0 = off 1 = on	0	RW		0	1	0	
024	Cfg DO1	Configuration output DO1	Functions, see [P:019]	7	RW		0	22	0	
025	OpMode BKP	Operation mode backup pump	0 = continuous operation 1 = interval operation 2 = Delayed switching on 3 = Delayed interval operation	7	RW		0	3	0	
026	SpdSetMode	Rotation speed setting mode	0 = off 1 = on	7	RW		0	1	0	
027	GasMode	Gas mode	0 = heavy gases 1 = light gases 2 = Helium	7	RW		0	2	0	
028	Cfg Remote	Configuration remote	0 = Standard 4 = Relay, inverted	7	RW		0	4	0	
030	VentMode	Venting mode	0 = delayed venting 1 = no venting 2 = direct venting	7	RW		0	2	0	



Parameter set

#	Display	Description	Functions	Data type	Access type	Unit	min.	max.	de- fault	
035	Cfg Acc A1	Configuration accessory connection A1	0 = fan 1 = Venting valve, closed without current 2 = Heating 3 = Backing pump 4 = Fan (temperature controlled) 5 = Sealing gas 6 = Always "0" 7 = Always "1" 8 = Power failure venting unit 9 = TMS Heating 10 = TMS Cooling 12 = Second venting valve 13 = Sealing gas monitoring 14 = Heating (bottom part temperature controlled)	7	RW		0	14	0	
036	Cfg Acc B1	Configuration accessory connection B1	Functions, see [P:035]	7	RW		0	14	1	
037	Cfg Acc A2	Configuration accessory connection A2	Functions, see [P:035]	7	RW		0	14	3	
038	Cfg Acc B2	Configuration accessory connection B2	Functions, see [P:035]	7	RW		0	14	2	
041	Press1HVen	Enable integrated HV Sensor (IKT only)	0 = off 1 = on 2 = On, when rotation speed switch point reached 3 = On, when pressure switch point underrun	7	RW		0	3	2	
045	Cfg Rel R1	Configuration, relay 1	Functions, see [P:019]	7	RW		0	22	0	
046	Cfg Rel R2	Configuration, relay 2	Functions, see [P:019]	7	RW		0	22	1	
047	Cfg Rel R3	Configuration, relay 3	Functions, see [P:019]	7	RW		0	22	3	
050	SealingGas	Sealing gas	0 = off 1 = on	0	RW		0	1	0	
055	Cfg AO1	Configuration output AO1	0 = actual rotation speed 1 = output 2 = current 3 = Always 0 V 4 = Always 10 V 5 = Follows AI1 6 = Pressure value 1 7 = Pressure value 2 8 = Fore-vacuum control	7	RW		0	8	0	
057	Cfg AI1	Configuration Input AI1	0 = Switched off 1 = Setpoint in rotation speed setting mode	7	RW		0	1	1	

#	Display	Description	Functions	Data type	Access type	Unit	min.	max.	de- fault	
060	CtrlVialnt	Control via interface	1 = remote 2 = RS-485 4 = PV.can 8 = Fieldbus 16 = E74 255 = Unlock interface selection	7	RW		1	255	1	
061	IntSelLckd	Interface selection locked	0 = off 1 = on	0	RW		0	1	0	
062	Cfg DI1	Configuration input DI1	Setting # [P:063/064] 0 = Deactivated 1 = Enable venting 2 = Heating 3 = Sealing gas 4 = Run-up time monitoring 5 = Rotation speed mode 7 = Enable HV sensor	7	RW		0	7	1	
063	Cfg DI2	Input DI2 configuration	Functions, see [P:062] Setting # [P:062/064]	7	RW		0	7	2	
064	Cfg DI3	Input DI3 configuration	Functions, see [P:062] Setting # [P:062/063]	7	RW		0	7	3	

Tbl. 12: Control commands

6.3 Status requests

#	Display	Description	Functions	Data type	Access type	Unit	min.	max.	de- fault	
300	RemotePrio	Remote priority	0 = no 1 = yes	0	R		0	1		
302	SpdSwPtAtt	Rotation speed switchpoint reached	0 = no 1 = yes	0	R		0	1		
303	Error code	Error code		4	R					
304	OvTempElec	Overtemperature electronic drive unit	0 = no 1 = yes	0	R		0	1		
305	OvTempPump	Overtemperature vacuum pump	0 = no 1 = yes	0	R		0	1		
306	SetSpdAtt	Target speed reached	0 = no 1 = yes	0	R		0	1		
307	PumpAccel	Vacuum pump accelerating	0 = no 1 = yes	0	R		0	1		
308	SetRotSpd	Set rotation speed (Hz)		1	R	Hz	0	999999		
309	ActualSpd	Actual rotation speed (Hz)		1	R	Hz	0	999999		
310	DrvCurrent	Drive current		2	R	A	0	9999.99		
311	OpHrsPump	Operating hours vacuum pump		1	R	h	0	65535		
312	Fw version	Firmware version electronic drive unit		4	R					
313	DrvVoltage	Drive voltage		2	R	V	0	9999.99		
314	OpHrsElec	Operating hours electronic drive unit		1	R	h	0	65535		

Parameter set

#	Display	Description	Func-tions	Data type	Access type	Unit	min.	max.	de-fault	
315	Nominal Spd	Nominal rotational speed (Hz)		1	R	Hz	0	999999		
316	DrvPower	Drive power		1	R	W	0	999999		
319	PumpCycles	Pump cycles		1	R		0	65535		✓
326	TempElec	Temperature electronics		1	R	°C	0	999999		
330	TempPmpBot	Temperature pump bottom part		1	R	°C	0	999999		
336	AccelDecel	Acceleration/deceleration		1	R	rpm/s	0	999999		
337	SealGasFlw	Sealing gas flow		1	R	sccm	0	999999		
342	TempBearng	Temperature bearing		1	R	°C	0	999999		
346	TempMotor	Temperature motor		1	R	°C	0	999999		
349	ElecName	Name of electronic drive unit		4	R					
354	HW Version	Hardware version electronic drive unit		4	R					
360	ErrHist1	Error code history, item 1		4	R					✓
361	ErrHist2	Error code history, item 2		4	R					✓
362	ErrHist3	Error code history, item 3		4	R					✓
363	ErrHist4	Error code history, item 4		4	R					✓
364	ErrHist5	Error code history, item 5		4	R					✓
365	ErrHist6	Error code history, item 6		4	R					✓
366	ErrHist7	Error code history, item 7		4	R					✓
367	ErrHist8	Error code history, item 8		4	R					✓
368	ErrHist9	Error code history, item 9		4	R					✓
369	ErrHist10	Error code history, item 10		4	R					✓
397	SetRotSpd	Set rotation speed (rpm)		1	R	rpm	0	999999		
398	ActualSpd	Actual rotation speed (rpm)		1	R	rpm	0	999999		
399	NominalSpd	Nominal rotation speed (rpm)		1	R	rpm	0	999999		

Tbl. 13: Status requests

6.4 Set value settings

#	Display	Description	Func-tions	Data type	Access type	Unit	min.	max.	default	
700	RUTimeSVal	Set value run-up time		1	RW	min	1	120	8	✓
701	SpdSwPt1	Rotation speed switch point 1		1	RW	%	50	97	80	✓
707	SpdSVal	Set value in rotation speed setting mode		2	RW	%	20	100	65	✓
708	PwrSVal	Set value power consumption		7	RW	%	10	100	100 ²⁾	✓
710	Swoff BKP	Backing pump switch-off threshold for interval operation		1	RW	W	0	1000	0	✓
711	SwOn BKP	Backing pump switch-on threshold for interval operation		1	RW	W	0	1000	0	✓
717	StdbySVal	Set value rotation speed at standby		2	RW	%	20	100	66.7	✓
719	SpdSwPt2	Rotation speed switch point 2		1	RW	%	5	97	20	✓

2) Depending on the pump type

#	Display	Description	Functions	Data type	Access type	Unit	min.	max.	default	
720	VentSpd	Venting rotation speed at delayed venting		7	RW	%	40	98	50	✓
721	VentTime	Venting time at delayed venting		1	RW	d	6	3600	3600	✓
730	PrsSwPt 1	Pressure switch point 1		10	RW	hPa				✓
732	PrsSwPt 2	Pressure switch point 2		10	RW	hPa				✓
739	PrsSn1Name	Name sensor 1		4	R					
740	Pressure 1	Pressure value 1		10	RW	hPa				✓
742	PrsCorrPi 1	Correction factor 1		2	RW					✓
749	PrsSn2Name	Name sensor 2		4	R					
750	Pressure 2	Pressure value 2		10	RW	hPa				✓
752	PrsCorrPi 2	Correction factor 2		2	RW					✓
777	NomSpdConf	Nominal rotation speed confirmation		1	RW	Hz	0	1500	0	✓
791	SlgWrnThrs	Sealing gas flow warning threshold		1	RW	sccm	5	200	15	✓
797	RS485Adr	RS-485 interface address		1	RW		1	255	1	✓

Tbl. 14: Set value settings

6.5 Additional parameter for the DCU



Additional parameter in the control panel

The basic parameter set is set in the electronic drive unit ex-factory. For controlling connected external components (e.g. vacuum measuring instruments), additional parameters (extended parameter set) are available in the corresponding Pfeiffer Vacuum display and control panels.

- Refer to the corresponding operating instructions of the respective components.
- Select the extended parameter set with parameter **[P:794] = 1**.

#	Display	Description	Functions	Data type	Access type	Unit	min.	max.	de-fault	
340	Pressure	Actual pressure value (ActiveLine)		7	R	hPa	$1 \cdot 10^{-10}$	$1 \cdot 10^3$		
350	Ctr Name	Display and control panel: type		4	R					
351	Ctr Software	Display and control panel: software version		4	R					
738	Gauge type	Type of pressure gauge		4	RW					
794	Param set	Parameter set	0 = Basic parameter set 1 = Extended parameter set	7	RW		0	1	0	
795	Servicelin	Insert service line		7	RW				795	

Tbl. 15: Parameter for DCU functions

7 Operation

7.1 Configuring the connections with the Pfeiffer Vacuum parameter set

The electronic drive unit is pre-configured with the factory default basic functions and is ready for operation. For individual requirements, you can configure most connections for the electronic drive unit with the parameter set.

7.1.1 Configuring the digital inputs

Option	Description
0 = Deactivated	Connection not operational
1 = Enable venting	Control corresponds to parameter [P:012]
2 = Heating	Control corresponds to parameter [P:001]
3 = Sealing gas	Control corresponds to parameter [P:050]
4 = Run-up time control	Control corresponds to parameter [P:004]
5 = Rotation speed mode	Control corresponds to parameter [P:026]
7 = Enable HV sensor	Control corresponds to parameter [P:041] (0 or 1 only)

Tbl. 16: Configuring parameters [P:062], [P:063] and [P:064]

7.1.2 Configuring digital outputs and relays

Meaning of "active" in the description

- for all digital outputs: V+ active high
- for all relays: contact changeover in accordance with the settings [P:028]

Option	Description
0 = Rotation speed switchpoint reached	active, once the switchpoint is reached
1 = No error	active, with trouble-free operation
2 = Error	active, if the error message is active
3 = Warning	active, if a warning message is active
4 = Error and/or warning	active, if an error and/or warning is active
5 = Set rotation speed reached	active, once the set rotation speed switch-point is reached
6 = Pump on	active, if pumping station on, motor on and no error
7 = Pump accelerating	active, if pumping station on, current rotation speed < set rotation speed
8 = Pump decelerating	active if pumping station on, current rotation speed > set rotation speed Pumping station off, rotation speed > 3 Hz
9 = Always "0"	GND for the control of an external device
10 = Always "1"	+24 V DC for the control of an external device
11 = Remote priority active	active, if the remote priority is active
12 = Heating	Control corresponds to parameter [P:001]
13 = Backing pump	Control corresponds to parameters [P:010] and [P:025]
14 = Sealing gas	Control corresponds to parameter [P:050]
15 = Pumping station	Control corresponds to parameter [P:010]
16 = Pump rotates	active, if rotation speed > 1 Hz
17 = Pump does not rotate	active, if rotation speed < 2 Hz
18 = TMS steady state ³⁾	active, if TMS set temperature stabilized

3) Only for vacuum pumps with a temperature management system (TMS)

Option	Description
19 = Pressure switch point 1 undershot	Control corresponds to parameters [P:730] ([P:740] < [P:730])
20 = Pressure switch point 2 undershot	Control corresponds to parameters [P:732] ([P:750] < [P:732])
21 = Fore-vacuum valve, delayed	+24 V DC time-delayed after pumping station on
22 = Backing pump stand-by	Control of backing pump standby mode

Tbl. 17: Configuring parameters [P:019] and [P:024], or [P:045], [P:046], [P:047] and [P:028]

7.1.3 Configuring the analog input

Option	Description
0 = Switched off	Connection not operational
1 = Setpoint in rotation speed setting mode	Rotation speed setting mode via pin 7 (0 - 10 V) and pin 11 (GND)

Tbl. 18: Configuring parameter [P:057]

7.1.4 Configuring the analog output

Option	Description
0 = rRotation speed	Rotation speed signal; 0 - 10 V DC = 0 - 100% × f _{Nominal}
1 = Output	Output signal; 0 - 10 V DC = 0 - 100% × P _{max}
2 = Current	Current signal; 0 - 10 V DC = 0 - 100% × I _{max}
3 = Always 0 V	Always GND
4 = Always 10 V	Output of permanent 10 V DC
5 = Follows AI1	Follows analog input 1
6 = Pressure value 1	Pressure value signal; 0 V: Error 1 V: Not reached 1.5 - 8.5 V for sensor RPT p (hPa) = 10 ^(U-5.5 V) 1.5 - 8.5 V for sensor IKT p (hPa) = 10 ^(U-10.5 V) 9 V: Exceed
7 = Pressure value 2	
8 = Fore-vacuum control	

Tbl. 19: Configuring parameter [P:055]

7.1.5 Configuring the accessory connections



Electronic drive unit TC 400 accessory connection

The electronic drive unit of the turbopump offers space for the connection of maximum 4 accessory devices. M12 connector sockets with the designation "accessory" are available for this purpose.

- The accessory connections have been preconfigured ex factory.
- After connecting preconfigured accessory devices, these are immediately ready for operation according to the factory settings.
- The use of other accessories for turbopumps is possible and requires settings in the configuration of the electronic drive unit.
- The desired accessory output is configured via RS-485 using Pfeiffer Vacuum display and control units or a PC.
- You can find detailed information in the "Electronic drive unit TC 400" operating instructions.

Procedure

- ▶ Carry out the configuration of the connections via parameter [P:035], [P:036], [P:037] or [P:038].

Option	Description
0 = Fan (continuous operation)	Control via pumping station parameters
1 = Venting valve, closed without current	Control via parameter enable venting. When using a venting valve closed without current
2 = Heating	Control via heating and speed switch point reached parameters
3 = Backing pump	Control via parameter pumping station and backing pump operating mode
4 = Fan (temperature controlled)	Control via parameter pumping station and temperature threshold value
5 = Sealing gas	Control via parameter pumping station and sealing gas
6 = Always "0"	GND for the control of an external device
7 = Always "1"	+24 V DC for the control of an external device
8 = Power failure venting unit	Control via parameter enable venting. When using a power failure venting unit
9 = TMS Heater ⁴⁾	Control via TMS switchbox
10 = TMS Cooling ⁵⁾	Control of the cooling water supply TMS
13 = Sealing gas monitoring	Control via parameter pumping station and sealing gas
14 = Heating (bottom part temperature controlled)	Control of the heating. Control via bottom part heating parameter

Tbl. 20: Accessory connections

7.1.6 Select interfaces

The option "Control via Interface" serves the display of the interface currently active in the electronic drive unit. The communication interfaces thus automatically achieve control priority.

Option	Description
1 = remote	Operation via connection "remote"
2 = RS-485	Operation via connection "RS-485"
4 = PV.can	For service purposes only
8 = Fieldbus	Operation via fieldbus
16 = E74	Operation via connection "E74"

Tbl. 21: Parameter [P:060]

7.2 Operating modes

7.2.1 Gas type-dependent operation

NOTICE
<p>Turbopump destruction due to gases with too high molecular masses</p> <p>The pumping of gases with impermissible high molecular masses leads to the destruction of the turbopump.</p> <ul style="list-style-type: none"> ▶ Make sure that the gas mode is set correctly by [P:027] in the electronic drive unit. ▶ Consult Pfeiffer Vacuum before you use gases with higher molecular masses (> 80).

4) Only for vacuum pumps with a temperature management system (TMS)

5) Only for vacuum pumps with a temperature management system (TMS)

High gas throughput and high rotation speed lead to strong friction heating of the rotor. To avoid overheating, power to rotation speed characteristics are implemented in the electronic drive unit. The power characteristic enables the operation of the turbopump at any rotation speed with the maximum permissible gas throughput without thermally overloading the turbopump. The maximum power consumption depends on the gas type. 3 characteristics are available for the parameterization in order to completely exhaust the turbopump's capacity for each gas type.

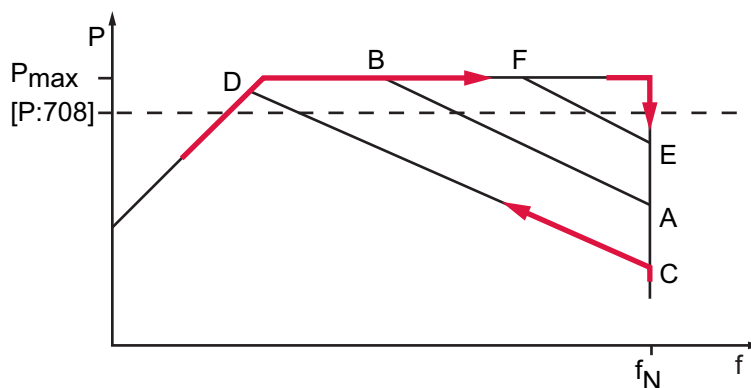

Fig. 6: Schematic diagram of power characteristics, example of heavy gases [P:027] = 0

P	Power consumption	C-D	Power characteristic in gas mode "0" (gases with molecular mass > 39, e.g. Argon)
f	Rotation speed	A-B	Power characteristic in gas mode "1" (gases with molecular mass ≤ 39)
P _{max}	Maximum power consumption	E-F	Power characteristic in gas mode "2" (Helium)
f _N	Nominal rotation speed		

Setting the gas mode

1. Check the current gas mode set with parameter [P:027].
2. Set the parameter [P:027] to the required value.
3. If necessary, set a lower frequency in rotation speed setting mode in order to avoid rotation speed fluctuations.

The turbopump runs up with maximum power consumption. When the nominal respective set rotation speed is reached, the electronic drive unit automatically switches over to the chosen power characteristic of the selected gas mode. An increase in the power consumption initially compensates an increasing gas throughput to keep the rotation speed constant. However, the turbopump heats up higher due to increasing gas friction. When the gas-type-dependent maximum power is exceeded, the electronic drive reduces the rotation speed until a permissible balance between power and gas friction is achieved.

7.2.2 Set value power consumption

Set parameter [P:708]

When setting the specified power consumption below 100%, the run-up time is extended.

1. Set the parameter [P:708] to the required value in %.
2. Where necessary, adjust the parameter [P:700] RUTimeSVal to avoid error messages when starting up.

7.2.3 Run-up time

The turbopump run-up is time-monitored ex-factory. There are various causes of prolonged run-up times, for example:

- Excessive gas throughput
- Leak in system
- Setpoint of the run-up time too low

Set parameter [P:700]

1. Where applicable, eliminate any external and application-related causes.
2. Adjust the run-up time with parameter [P:700].

7.2.4 Rotation speed switch points

You can use the rotation speed switch point for the “turbopump operational for the process” message. Exceeding or underrunning the active rotation speed switch point activates a signal at the pre-configured output on the electronic drive unit and at the status parameter **[P:302]**.

Rotation speed switch point 1

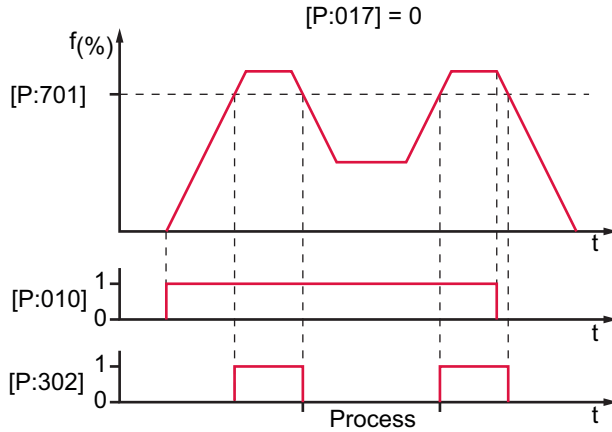

Fig. 7: Rotation speed switch point 1 active

Adjusting rotation speed switch point 1

Signal output and status parameters are based on the set value for the rotation speed switch point 1 **[P:701]**.

1. Set the parameter **[P:701]** to the required value in %.
2. Set the parameter **[P:017]** to "0".

Rotation speed switch points 1 & 2

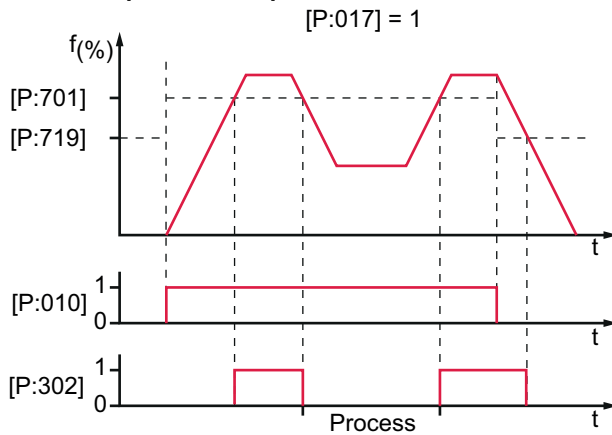

Fig. 8: Rotation speed switch points 1 & 2 active, [P:701] > [P:719]

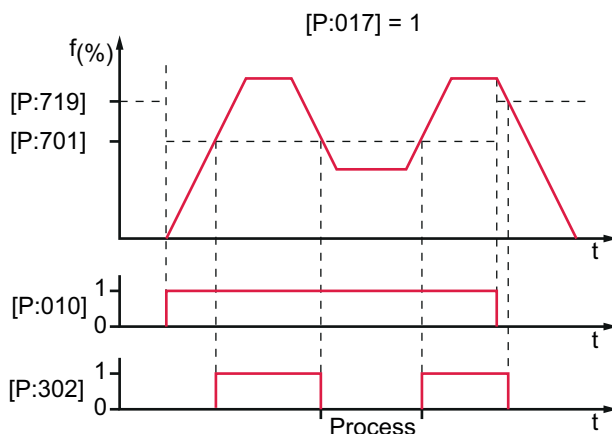

Fig. 9: Rotation speed switch points 1 & 2 active, [P:701] < [P:719]

Setting the rotation speed switch points 1 & 2

1. Set the parameter [P:701] to the required value in %.
2. Set the parameter [P:719] to the required value in %.
3. Set the parameter [P:017] to "1".

When the pumping station [P:010] is switched on, rotation speed switch point 1 is the signal generator. When the pumping station is switched off, the signal output and status request orientate at rotation speed switch point 2. The signal output is subject to the hysteresis between both switchpoints.

7.2.5 Rotation speed setting mode

The rotation speed setting mode reduces the speed and hence the pumping speed of the turbopump. The pumping speed of the turbopump changes proportional to its rotation speed. Standby mode is ineffective during rotation speed setting mode. The set value in rotation speed setting mode [P:707] sets the set rotation speed. The rotation speed switch point varies with the set rotation speed. Underrunning or exceeding the set value in rotation speed setting mode activates or deactivates the status signal [P:306] SetSpdAtt.



Permissible variable rotation speed

Values in the rotation speed setting mode or standby mode are subject to the permissible rotation speed range of the respective vacuum pump (technical data). Underrunning the minimum permissible value leads to the warning message **Wrn100**. The electronic drive unit automatically adjusts the set rotation speed to the next valid value.

Set the rotation speed setting mode

1. Set the parameter [P:707] to the required value in %.
2. Set the parameter [P:026] to "1".
3. Check the set rotation speed (parameter [P:308] or [P:397]).

7.2.6 Standby

Pfeiffer Vacuum recommends standby mode for the turbopump during process and production stops. When standby mode is active, the electronic drive unit reduces the rotation speed of the turbo pump. Standby mode is ineffective during rotation speed setting mode. The factory setting for stand-by mode is 66.7 % of the nominal rotation speed. Underrunning or exceeding the set value in standby mode activates or deactivates the status signal [P:306] SetSpdAtt.



Permissible variable rotation speed

Values in the rotation speed setting mode or standby mode are subject to the permissible rotation speed range of the respective vacuum pump (technical data). Underrunning the minimum permissible value leads to the warning message **Wrn100**. The electronic drive unit automatically adjusts the set rotation speed to the next valid value.

Setting the related parameters

1. Set the parameter **[P:717]** to the required value in %.
2. Set the parameter **[P:026]** to "0".
3. Set the parameter **[P:002]** to "1".
4. Check the set rotation speed (parameter **[P:308]** or **[P:397]**).

7.2.7 Confirming the speed specification

The typical nominal rotation speed of a turbopump is preset at the factory in the electronic drive unit. If the electronic drive unit is replaced or a different pump type is used, the reference set value of the nominal rotation speed is cleared. The manual confirmation of the nominal rotation speed is part of a redundant safety system as a measure for preventing excess rotation speed.

HiPace	Confirmation of nominal rotation speed [P:777]
300	1000 Hz
400 / 700 / 800	820 Hz

Tbl. 22: Characteristic nominal rotation speeds of the turbopumps

Required aids

- A connected Pfeiffer Vacuum display and control unit.
- Knowledge of the configuration and setting of electronic drive unit operating parameters.

Set parameter [P:777]

- ▶ Set the parameter **[P:777]** according to the pump type.

Once the nominal rotation speed is reached, the turbopump will run at idle without additional gas throughput. Depending on process or application requirements, the nominal rotation speed can be reduced in rotation speed setting mode or stand-by mode.

7.2.8 Backing pump operating modes

Operation of a connected backing pump via the electronic drive unit depends on the backing pump type.

Operating mode [P:025]	Recommended booster pump
"0" Continuous operation	All backing pumps
"1" Interval mode	Diaphragm pumps only
"2" Delayed switching on	All backing pumps
"3" Delayed interval mode	Diaphragm pumps only

Tbl. 23: Backing pump operating modes

Setting continuous operation

With "pumping station on", the electronic drive unit sends a signal to the configured accessory connection to switch on the backing pump.

1. Set the parameter **[P:025]** to "0".
2. Use this signal for the control of a fore-vacuum safety valve.

Set interval operation and determine the switching threshold

Interval operation extends the service life of the diaphragm of a connected diaphragm pump. Either a diaphragm pump with a built-in semiconductor relay or an interconnected relay box with a semiconductor relay is required for interval operation. The electronic drive unit switches the backing pump on or off depending on the power consumption of the turbopump. A relationship to the fore-vacuum pressure results from the power consumption. The backing pump operating mode offers adjustable switch-on and switch-off thresholds. Fluctuations in the power consumption of idling turbopumps and varying fore-vacuum pressures of the backing pumps require individual settings of the interval operation.

Pfeiffer Vacuum recommends interval operation between 5 and 10 hPa. A pressure gauge and a dosing valve are required to set the switching thresholds.

1. Set the parameter **[P:025]** to "1".
2. Switch on the vacuum system with the parameter **[P:010]** ("pumping station").
3. Wait for the run-up.

4. Allow the gas to run via the dosing valve and set the fore-vacuum pressure to 10 hPa.
5. Read the drive power at parameter **[P:316]** and note the value.
6. Set the switch-on threshold of the backing pump with parameter **[P:711]** to the determined drive power for a 10 hPa fore-vacuum pressure.
7. Reduce the fore-vacuum pressure to 5 hPa.
8. Read the drive power at parameter **[P:316]** and note the value.
9. Set the switch-off threshold of the backing pump with parameter **[P:710]** to the determined drive power for a 5 hPa fore-vacuum pressure.

Delayed switching on

Simultaneous switching on of the backing pump and turbopump may cause undesired gas flow. To avoid this, depending on the process or application requirements, you can operate the backing pump with a delayed switch-on. The delayed switch-on depends on the rotation speed of the turbopump. The delayed switch-on has a fixed value of 360 rpm in the electronic drive unit.

- Switch-off threshold, parameter **[P:710]**
 - Switch-on threshold, parameter **[P:711]**
 - Delay 8 s.
1. Set the parameter **[P:025]** to "2".
 2. Use this signal for the control of a fore-vacuum safety valve.

Delayed interval operation

Fluctuations during the interval operation may lead to the underrunning or exceeding the switching thresholds. To avoid undesired switching of the backing pump you can operate the interval operation using a switching delay, depending on the process or application requirements. The delay is depending on a permanently uninterrupted exceedence or undershot of the specified switching threshold.

- Switch-off threshold, parameter **[P:710]**
 - Switch-on threshold, parameter **[P:711]**
 - Delay 8 s.
1. Set the parameter **[P:025]** to "3".
 2. Use this signal for the control of a fore-vacuum safety valve.

7.2.9 Backing pump standby mode

In case you are using a Pfeiffer Vacuum backing pump with rotation speed control, this can be used in standby mode by configuring the digital output **[P:019]** or **[P:024]**. The power consumption of the turbopump has a direct influence on the rotation speed of the backing pump.

Configuring the stand-by mode

1. Establish the connection of the backing pump using a suitable connecting cable.
2. Set parameter **[P:019]** or **[P:024]** to "22" (backing pump stand-by mode).
3. Find the respective standby rotation speed from the corresponding operating instructions of the backing pump.

7.2.10 Operation with accessories



Installation and operation of accessories

Pfeiffer Vacuum offers a series of special, compatible accessories for its products.

- Information and ordering options for approved [accessories](#) can be found online.
- The following accessories are not included in the scope of supply.

Procedure

- ▶ Carry out the configuration of the connections via parameter **[P:035]**, **[P:036]**, **[P:037]** or **[P:038]**.

Configuring the heating

Activation of the connected housing heating depends on the rotation speed switch point 1 (factory setting $80\% \times f_{Nominal}$).

- ▶ Switch the heating on or off with parameter **[P:001]**.

Configuring the fan

1. Set the selected parameter to "0" for continuous operation of the fan.
2. Set the selected parameter to "4" for temperature-controlled operation of the fan.

Configuring the sealing gas valve

- ▶ Using parameter **[P:050]**, switch a connected sealing gas valve on or off via the pre-configured output.

Monitoring the sealing gas

1. Set the selected parameter to "13".
2. Set the parameter **[P:791]** to the desired sealing gas flow for the warning threshold.
3. Query the sealing gas flow via parameter **[P:337]**.

Configuring the bottom part heating

The accessory output controls the heating cartridges that maintain the bottom part of the turbopump at maximum temperature. The control is carried out according to pump-specific requirements, depending on the current power input of the vacuum pump and the switch point.

1. Set the selected parameter to "14".
2. Switch the heating on or off with parameter **[P:001]**.
3. Query the bottom part temperature via parameter **[P:330]**.

7.2.11 Venting modes

The function "pumping station" enables the venting mode of the turbopump after switching off. The signal output is carried out with a fixed delay.

Selecting the venting mode

1. Set parameter **[P:012]** to "1".
2. Select the venting mode with parameter **[P:030]** (3 possible modes).

Delayed venting

1. Configure the beginning and the time for the venting after "pumping station off" depending on the rotation speed of the turbopump.
2. Set parameter **[P:030]** to "0".
3. With parameter **[P:720]**, set the venting speed to the nominal rotation speed in %.
4. With parameter **[P:721]**, set the venting speed in s.

The venting valve opens for the set venting time. In case of a power failure, the venting starts when underrunning the set venting speed. The venting period depends on the residual energy delivered by the turning rotor. The venting process stops, when power is restored.

No venting

In this operating mode, the venting is deactivated.

- ▶ Set parameter **[P:030]** to "1".

Direct venting

Venting starts with a delay of 6 s after "pumping station off". When the pumping station function is switched back on, the venting valve closes automatically. After a power failure, the venting starts after underrunning a fixed type-specific rotation speed. The venting process continues, when power is restored.

- ▶ Set parameter **[P:030]** to "2".

7.3 Switching on the turbopump

The function "pumping station" **[P:010]** comprises the turbopump operation with control of all connected accessory devices (e.g. backing pump).

Procedure

After successfully completing the self-test, the electronic drive unit resets pending and corrected error messages. The turbopump starts and all connected accessory devices start operation according to their configuration.

1. Set the parameter **[P:023]** to "1".
 - The parameter **[P:023]** switches on the motor of the turbopump.
2. Set the parameter **[P:010]** to "1".

7.4 Switching off the turbopump

Procedure









The electronic drive unit switches off the turbopump and activates pre-set accessory options (e.g. venting ON, backing pump OFF).

1. Set the parameter **[P:010]** to "0".
2. Wait until the turbopump comes to a complete standstill.
3. Disconnect the power supply according to the operating instructions of the turbopump or the power supply pack.

7.5 Operation monitoring

7.5.1 Operating mode display via LED

LEDs on the electronic drive unit show the basic operating states of the vacuum pump. A differentiated error and warning display is only possible for operation with the Pfeiffer Vacuum display and control unit or a PC.

LED	Symbol	LED status	Display	Meaning
Green 		Off	—	Currentless
		On, flashing		"pumping station OFF", rotation speed ≤ 60 rpm
		On, inverse flashing		"pumping station ON", set rotation speed not reached
		On, constant		"pumping station ON", set rotation speed reached
		On, flashing		"pumping station OFF", speed > 60 rpm
Yellow 	△	Off	—	No warning
		On, constant		Warning
Red 	⚡	Off	—	No error, no warning
		On, constant		Error, malfunction

Tbl. 24: Behavior and meaning of the LEDs on the electronic drive unit

7.5.2 Temperature monitoring

If threshold values are exceeded, output signals from temperature sensors bring the turbopump to a safe condition. Depending on the type, temperature thresholds for warning and error messages are immutably stored in the electronic drive unit. For information purposes, various status requests are set up in the parameter set.

- In order to avoid switching off the turbopump, the electronic drive unit already reduces the power consumption in case of exceeding the warning threshold for excess temperature.
 - Examples are an impermissible motor temperature, or impermissibly high housing temperature.
- Further reduction of drive power and thus decreasing speed can potentially lead to underrun the rotation speed switchpoint. The turbopump switches off.
- Exceeding the temperature threshold for error messages switches off the turbopump immediately.

8 Recycling and disposal

WARNING

Health hazard through poisoning from toxic contaminated components or devices

Toxic process media result in contamination of devices or parts of them. During maintenance work, there is a risk to health from contact with these poisonous substances. Illegal disposal of toxic substances causes environmental damage.

- ▶ Take suitable safety precautions and prevent health hazards or environmental pollution by toxic process media.
- ▶ Decontaminate affected parts before carrying out maintenance work.
- ▶ Wear protective equipment.



Environmental protection

You **must** dispose of the product and its components in accordance with all applicable regulations for protecting people, the environment and nature.

- Help to reduce the wastage of natural resources.
- Prevent contamination.



Environmental protection

The product and its components **must be disposed of in accordance with the applicable regulations relating to environmental protection and human health**, with a view to reducing natural resource wastage and preventing pollution.

8.1 General disposal information

Pfeiffer Vacuum products contain materials that you must recycle.

- ▶ Dispose of our products according to the following:
 - Iron
 - Aluminium
 - Copper
 - Synthetic
 - Electronic components
 - Oil and fat, solvent-free
- ▶ Observe the special precautionary measures when disposing of:
 - Fluoroelastomers (FKM)
 - Potentially contaminated components that come into contact with media

8.2 Dispose of electronic drive unit

Electronic components and their housings contain material that must be recycled.

- ▶ Dispose of electronic components in a safe manner according to locally applicable regulations.

9 Malfunctions

9.1 General

WARNING

Risk of injury from parts moving after a power failure or troubleshooting

The "pumping station" function of the electronic drive unit will remain active after a power failure or if errors occur that shut down the vacuum pump or the system. When power is restored or after acknowledging a fault, the vacuum pump runs up automatically. There is a risk of injury to fingers and hands if they enter the operating range of rotating parts.

- ▶ Always keep the mains connection freely accessible so you can disconnect it at any time.
- ▶ Remove present mating plugs or bridges from the electronic drive unit possibly before the mains power returns, as these can cause an automatic run-up.
- ▶ Switch the pump off using the "Pumping station" function (parameter **[P:010]**).

Malfunctions of turbopump and electronic drive unit always result in a warning or error messages. In both cases, you receive an error code that you can read out via the interfaces of the electronic drive unit. Generally, the LEDs on the electronic drive unit show the operating messages. If an error occurs, the turbo pump and connected devices switch off. The selected venting mode starts after a preset delay.

9.2 Error codes

Errors (** Error E—— **) always cause the connected peripheral devices to be switched off.

Warnings (* Warning F —— *) do not cause components to be switched off.

Handling malfunction messages

1. Read out the error codes via the display and control panel or the PC.
2. Remove the cause of the malfunction.
3. Reset the error message with parameter **[P:009]** or by pressing the button  on the DCU.

Error code	Problem	Possible causes	Remedy
Err001	Excess rotation speed	<ul style="list-style-type: none"> • Device defective 	<ul style="list-style-type: none"> • Contact Pfeiffer Vacuum Service. • Only acknowledge for rotational speed f = 0
Err002	Excess voltage	<ul style="list-style-type: none"> • Incorrect power supply pack • Incorrect mains input voltage 	<ul style="list-style-type: none"> • Check the power supply pack type • Check the mains input voltage • Only acknowledge for rotational speed f = 0
Err006	Run-up error	<ul style="list-style-type: none"> • Run-up time threshold set too low • Gas flow in recipients through leaks or open valves • Still below speed-control switch point run-up time expires 	<ul style="list-style-type: none"> • Adjust the run-up time to the process conditions • Check the vacuum chambers for leaks and closed valves • Adjust the rotation speed switch point
Err007	Operating fluid low	<ul style="list-style-type: none"> • Operating fluid low 	<ul style="list-style-type: none"> • Check the operating fluid • Only acknowledge for rotational speed f = 0
Err008	Electronic drive unit - turbopump connection faulty	<ul style="list-style-type: none"> • Connection to turbopump faulty 	<ul style="list-style-type: none"> • Check the connections • Only acknowledge for rotational speed f = 0
Err010	Internal device error	<ul style="list-style-type: none"> • Device defective 	<ul style="list-style-type: none"> • Contact Pfeiffer Vacuum Service. • Only acknowledge for rotational speed f = 0
Err021	Electronic drive unit does not detect turbopump	<ul style="list-style-type: none"> • Incompatible software version • Device defective 	<ul style="list-style-type: none"> • Contact Pfeiffer Vacuum Service. • Only acknowledge for rotational speed f = 0
Err041	Drive fault	<ul style="list-style-type: none"> • Device defective 	<ul style="list-style-type: none"> • Contact Pfeiffer Vacuum Service. • Only acknowledge for rotational speed f = 0

Error code	Problem	Possible causes	Remedy
Err043	Internal configuration error	<ul style="list-style-type: none"> Device defective 	<ul style="list-style-type: none"> Contact Pfeiffer Vacuum Service.
Err044	Excess temperature, electronics	<ul style="list-style-type: none"> Insufficient cooling 	<ul style="list-style-type: none"> Improve the cooling Check the operating conditions
Err045	Excess temperature, motor	<ul style="list-style-type: none"> Insufficient cooling 	<ul style="list-style-type: none"> Improve the cooling Check the operating conditions
Err046	Internal initialization error	<ul style="list-style-type: none"> Device defective 	<ul style="list-style-type: none"> Contact Pfeiffer Vacuum Service.
Err073	Axial magnetic bearing overload	<ul style="list-style-type: none"> Rate of pressure rise too high 	<ul style="list-style-type: none"> Check the operating conditions Only acknowledge for rotational speed $f = 0$
Err074	Radial magnetic bearing overload	<ul style="list-style-type: none"> Rate of pressure rise too high 	<ul style="list-style-type: none"> Check the operating conditions Only acknowledge for rotational speed $f = 0$
Err089	Rotor instable	<ul style="list-style-type: none"> Impacts, vibrations Device defective 	<ul style="list-style-type: none"> Check the operating conditions Contact Pfeiffer Vacuum Service.
Err091	Internal device error	<ul style="list-style-type: none"> Device defective 	<ul style="list-style-type: none"> Contact Pfeiffer Vacuum Service.
Err092	Unknown connection panel	<ul style="list-style-type: none"> Device defective 	<ul style="list-style-type: none"> Contact Pfeiffer Vacuum Service.
Err093	Motor temperature evaluation faulty	<ul style="list-style-type: none"> Device defective 	<ul style="list-style-type: none"> Contact Pfeiffer Vacuum Service.
Err094	Electronics temperature evaluation faulty	<ul style="list-style-type: none"> Device defective 	<ul style="list-style-type: none"> Contact Pfeiffer Vacuum Service.
Err098	Internal communication error	<ul style="list-style-type: none"> External faults Device defective 	<ul style="list-style-type: none"> Contact Pfeiffer Vacuum Service. Only acknowledge for rotational speed $f = 0$
Err107	Final stage group error	<ul style="list-style-type: none"> External faults Device defective 	<ul style="list-style-type: none"> Contact Pfeiffer Vacuum Service. Only acknowledge for rotational speed $f = 0$
Err108	Rotation speed measurement faulty	<ul style="list-style-type: none"> External faults Device defective 	<ul style="list-style-type: none"> Contact Pfeiffer Vacuum Service. Only acknowledge for rotational speed $f = 0$
Err109	Software not released	<ul style="list-style-type: none"> Faulty software update 	<ul style="list-style-type: none"> Contact Pfeiffer Vacuum Service.
Err110	Operating fluid evaluation faulty	<ul style="list-style-type: none"> Operating fluid sensor faulty 	<ul style="list-style-type: none"> Contact Pfeiffer Vacuum Service. Only acknowledge for rotational speed $f = 0$
Err111	Operating fluid pump communication error	<ul style="list-style-type: none"> External faults Device defective 	<ul style="list-style-type: none"> Contact Pfeiffer Vacuum Service. Only acknowledge for rotational speed $f = 0$
Err112	Operating fluid pump group error	<ul style="list-style-type: none"> External faults Device defective 	<ul style="list-style-type: none"> Contact Pfeiffer Vacuum Service. Only acknowledge for rotational speed $f = 0$
Err113	Rotor temperature evaluation faulty	<ul style="list-style-type: none"> Device defective 	<ul style="list-style-type: none"> Contact Pfeiffer Vacuum Service.
Err114	Final stage temperature evaluation faulty	<ul style="list-style-type: none"> Device defective 	<ul style="list-style-type: none"> Contact Pfeiffer Vacuum Service.
Err117	Excess temperature, pump lower part	<ul style="list-style-type: none"> Insufficient cooling 	<ul style="list-style-type: none"> Improve the cooling Check the operating conditions
Err118	Excess temperature, final stage	<ul style="list-style-type: none"> Insufficient cooling 	<ul style="list-style-type: none"> Improve the cooling Check the operating conditions
Err119	Excess temperature, bearing	<ul style="list-style-type: none"> Insufficient cooling Incorrect gas mode selected Insufficient sealing gas flow 	<ul style="list-style-type: none"> Improve the cooling Check the operating conditions
Err143	Operating fluid pump excess temperature	<ul style="list-style-type: none"> Insufficient cooling 	<ul style="list-style-type: none"> Improve the cooling Check the operating conditions Only acknowledge for rotational speed $f = 0$
Err777	Nominal rotation speed not confirmed	<ul style="list-style-type: none"> Nominal rotation speed not confirmed after replacing the electronic drive unit 	<ul style="list-style-type: none"> Confirm the nominal rotation speed with [P:777] Only acknowledge for rotational speed $f = 0$
Err800	Magnetic bearing overflow	<ul style="list-style-type: none"> Impacts, vibrations Device defective 	<ul style="list-style-type: none"> Contact Pfeiffer Vacuum Service. Check the operating conditions Only acknowledge for rotational speed $f = 0$
Err802	Magnetic bearing sensor technology fault	<ul style="list-style-type: none"> Calibration values invalid Device defective 	<ul style="list-style-type: none"> Contact Pfeiffer Vacuum Service. Perform a calibration procedure Only acknowledge for rotational speed $f = 0$

Error code	Problem	Possible causes	Remedy
Err810	Internal configuration error	<ul style="list-style-type: none"> Incompatible software version 	<ul style="list-style-type: none"> Contact Pfeiffer Vacuum Service. Only acknowledge for rotational speed $f = 0$
Err815	Magnetic bearing overflow	<ul style="list-style-type: none"> Impacts, vibrations Device defective 	<ul style="list-style-type: none"> Contact Pfeiffer Vacuum Service. Check the operating conditions Only acknowledge for rotational speed $f = 0$
Err890	Safety bearing worn	<ul style="list-style-type: none"> Safety bearing wear > 100% 	<ul style="list-style-type: none"> Contact Pfeiffer Vacuum Service.
Err891	Rotor imbalance too high	<ul style="list-style-type: none"> Rotor imbalance > 100% 	<ul style="list-style-type: none"> Contact Pfeiffer Vacuum Service. Only acknowledge for rotational speed $f = 0$

Tbl. 25: Error messages of the electronic drive unit

Error code	Problem	Possible causes	Remedy
Wrn001	TMS heat-up time expired	<ul style="list-style-type: none"> Internal timer for heat-up monitoring exceeded 	<ul style="list-style-type: none"> Check the operating conditions Check the mains input voltage
Wrn003	TMS temperature invalid	<ul style="list-style-type: none"> TMS temperature not in the permissible range between 5 °C and 85 °C TMS temperature sensor defective 	<ul style="list-style-type: none"> Check the operating conditions Contact Pfeiffer Vacuum Service.
Wrn007	Undervoltage or power failure	<ul style="list-style-type: none"> Mains failure Power supply pack dimensioned insufficiently 	<ul style="list-style-type: none"> Check the power supply pack type Check the mains input voltage
Wrn016	Accessory configuration invalid	<ul style="list-style-type: none"> Impermissible configuration of the accessory outputs 	<ul style="list-style-type: none"> Check the configuration of all accessory outputs
Wrn018	Operating supremacy conflict	<ul style="list-style-type: none"> Pumping station switched on with [P:010] while E74 input "start/stop" is off (opened) 	<ul style="list-style-type: none"> Switch on the pumping station via E74 "start/stop" Switch [P:010] off
Wrn021	Blocking signal invalid	<ul style="list-style-type: none"> Signal of the blocking signal monitoring outside the valid range 	<ul style="list-style-type: none"> Check the connections of the sealing gas monitoring Check the sealing gas supply
Wrn034	Sealing gas flow too low	<ul style="list-style-type: none"> Signal of the sealing gas monitoring valid but below the set threshold [P:791] 	<ul style="list-style-type: none"> Check and improve the sealing gas supply
Wrn045	Motor high temperature	<ul style="list-style-type: none"> Insufficient cooling 	<ul style="list-style-type: none"> Improve the cooling Check the operating conditions
Wrn076	Electronics high temperature	<ul style="list-style-type: none"> Insufficient cooling 	<ul style="list-style-type: none"> Improve the cooling Check the operating conditions
Wrn089	Imbalance high	<ul style="list-style-type: none"> Rotor imbalance 	<ul style="list-style-type: none"> Contact Pfeiffer Vacuum Service.
Wrn097	Invalid pump information	<ul style="list-style-type: none"> Internal communication error 	<ol style="list-style-type: none"> Shut down pumping station Wait until the turbopump comes to a standstill Disconnect the power supply If this reoccurs, contact Pfeiffer Vacuum Service
Wrn098	Incomplete pump information	<ul style="list-style-type: none"> Internal communication error 	<ol style="list-style-type: none"> Shut down pumping station Wait until the turbopump comes to a standstill Disconnect the power supply If this reoccurs, contact Pfeiffer Vacuum Service
Wrn100	Minimum speed not reached	<ul style="list-style-type: none"> Settings of the set rotation speed below the pump-specific minimum speed 	<ul style="list-style-type: none"> Check [P:707] or [P:717] Obtain the valid rotation speed range from the technical data of the turbopump
Wrn106	High rotor temperature	<ul style="list-style-type: none"> High gas throughput Impermissible thermal radiation Impermissible magnetic field 	<ul style="list-style-type: none"> Check the operating conditions
Wrn113	Inaccurate rotor temperature	<ul style="list-style-type: none"> Internal communication error 	<ul style="list-style-type: none"> Contact Pfeiffer Vacuum Service.

Error code	Problem	Possible causes	Remedy
Wrn115	Pump lower part temperature evaluation faulty	<ul style="list-style-type: none"> Device defective 	<ul style="list-style-type: none"> Contact Pfeiffer Vacuum Service.
Wrn116	Bearing temperature evaluation faulty	<ul style="list-style-type: none"> Device defective 	<ul style="list-style-type: none"> Contact Pfeiffer Vacuum Service.
Wrn117	Pump lower part high temperature	<ul style="list-style-type: none"> Insufficient cooling Incorrect gas mode selected 	<ul style="list-style-type: none"> Improve the cooling Check the operating conditions
Wrn118	Final stage high temperature	<ul style="list-style-type: none"> Insufficient cooling Incorrect gas mode selected 	<ul style="list-style-type: none"> Improve the cooling Check the operating conditions
Wrn119	Bearing high temperature	<ul style="list-style-type: none"> Insufficient cooling Incorrect gas mode selected Insufficient sealing gas flow 	<ul style="list-style-type: none"> Improve the cooling Check the operating conditions
Wrn143	High operating fluid pump temperature	<ul style="list-style-type: none"> Insufficient cooling 	<ul style="list-style-type: none"> Improve the cooling
Wrn168	High delay	<ul style="list-style-type: none"> Rate of pressure rise too high Venting rate too high 	<ul style="list-style-type: none"> Check the venting rate Adapt the venting rate to the pump
Wrn801	Braking transistor defective	<ul style="list-style-type: none"> Device defective 	<ul style="list-style-type: none"> Contact Pfeiffer Vacuum Service.
Wrn806	Brake resistance defective	<ul style="list-style-type: none"> Device defective 	<ul style="list-style-type: none"> Contact Pfeiffer Vacuum Service.
Wrn807	Calibration requirement	<ul style="list-style-type: none"> Calibration expired 	<ul style="list-style-type: none"> Calibrate the turbopump by starting from standstill
Wrn890	Safety bearing wear too high	<ul style="list-style-type: none"> Safety bearing wear > 75 % 	<ul style="list-style-type: none"> Contact Pfeiffer Vacuum Service.
Wrn891	High rotor imbalance	<ul style="list-style-type: none"> Rotor imbalance > 75 % 	<ul style="list-style-type: none"> Contact Pfeiffer Vacuum Service.

Tbl. 26: Warning messages of the electronic drive unit

9.3 Warning and error messages when operating with DCU

Besides the device-specific warning and error messages on the electronic drive unit, additional messages are displayed with the connected display and control panel.

Display in DCU	Problem	Possible causes	Remedy
* Warning F110 *	Pressure gauge	<ul style="list-style-type: none"> Pressure gauge faulty Connection to the pressure gauge disconnected during operation 	<ul style="list-style-type: none"> Check the cable connection Carry out a restart with pressure gauge connected Replace the pressure gauge completely
** Error E040 **	Hardware error	<ul style="list-style-type: none"> external RAM faulty 	<ul style="list-style-type: none"> Contact Pfeiffer Vacuum Service.
** Error E042 **	Hardware error	<ul style="list-style-type: none"> EPROM checksum incorrect 	<ul style="list-style-type: none"> Contact Pfeiffer Vacuum Service.
** Error E043 **	Hardware error	<ul style="list-style-type: none"> E²PROM write error 	<ul style="list-style-type: none"> Contact Pfeiffer Vacuum Service.
** Error E090 **	Internal device error	<ul style="list-style-type: none"> RAM not large enough DCU is connected to incorrect electronic drive unit 	<ul style="list-style-type: none"> Contact Pfeiffer Vacuum Service. Connect the DCU to the correct electronic drive unit
** Error E698 **	Communication error	<ul style="list-style-type: none"> Electronic drive unit is not responding 	<ul style="list-style-type: none"> Contact Pfeiffer Vacuum Service.

Tbl. 27: Warning and error messages when using a DCU

10 Service solutions by Pfeiffer Vacuum

We offer first-class service

High vacuum component service life, in combination with low downtime, are clear expectations that you place on us. We meet your needs with efficient products and outstanding service.

We are always focused on perfecting our core competence – servicing of vacuum components. Once you have purchased a product from Pfeiffer Vacuum, our service is far from over. This is often exactly where service begins. Obviously, in proven Pfeiffer Vacuum quality.

Our professional sales and service employees are available to provide you with reliable assistance, worldwide. Pfeiffer Vacuum offers an entire range of services, from [original replacement parts](#) to [service contracts](#).

Make use of Pfeiffer Vacuum service

Whether preventive, on-site service carried out by our field service, fast replacement with mint condition replacement products, or repair carried out in a [Service Center](#) near you – you have various options for maintaining your equipment availability. You can find more detailed information and addresses on our homepage, in the [Pfeiffer Vacuum Service](#) section.

You can obtain advice on the optimal solution for you, from your [Pfeiffer Vacuum representative](#).

For fast and smooth service process handling, we recommend the following:



1. Download the up-to-date form templates.
 - [Explanations of service requests](#)
 - [Service requests](#)
 - [Contamination declaration](#)



- a) Remove and store all accessories (all external parts, such as valves, protective screens, etc.).
 - b) If necessary, drain operating fluid/lubricant.
 - c) If necessary, drain coolant.
2. Complete the service request and contamination declaration.



3. Send the forms by email, fax, or post to your local [Service Center](#).



4. You will receive an acknowledgment from Pfeiffer Vacuum.

PFEIFFER VACUUM

Submission of contaminated products

No microbiological, explosive, or radiologically contaminated products will be accepted. Where products are contaminated, or the contamination declaration is missing, Pfeiffer Vacuum will contact you before starting service work. Depending on the product and degree of pollution, **additional decontamination costs** may be incurred.

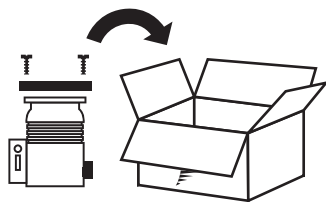

5. Prepare the product for transport in accordance with the provisions in the contamination declaration.
 - a) Neutralize the product with nitrogen or dry air.
 - b) Seal all openings with blind flanges, so that they are airtight.
 - c) Shrink-wrap the product in suitable protective foil.
 - d) Package the product in suitable, stable transport containers only.
 - e) Maintain applicable transport conditions.

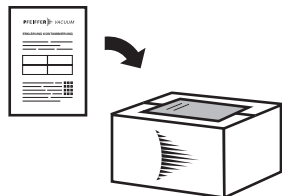

6. Attach the contamination declaration to the **outside** of the packaging.

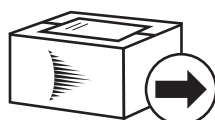

7. Now send your product to your local Service Center.



8. You will receive an acknowledgment/quotation, from Pfeiffer Vacuum.

PFEIFFER VACUUM

Our sales and delivery conditions and repair and maintenance conditions for vacuum devices and components apply to all service orders.

Declaration of conformity

Declaration for product(s) of the type:

Electronic drive unit

TC 400

We hereby declare that the listed product satisfies all relevant provisions of the following **European Directives**.

Electromagnetic compatibility 2014/30/EU

Low voltage 2014/35/EC

Restriction of the use of certain hazardous substances 2011/65/EU

Restriction of the use of certain hazardous substances, delegated directive 2015/863/EU

Harmonized standards and applied national standards and specifications:

DIN EN 61000-3-2: 2014

DIN EN 61000-3-3: 2013

DIN EN 61010-1: 2011

DIN EN 61326-1: 2013

DIN EN 62061: 2013

DIN EN IEC 63000: 2019

Semi F47-0200

Semi S2-0706

Signature:



(Daniel Sälzer)
Managing Director

Pfeiffer Vacuum GmbH
Berliner Straße 43
35614 Asslar
Germany

Asslar, 2019-12-09



VACUUM SOLUTIONS FROM A SINGLE SOURCE

Pfeiffer Vacuum stands for innovative and custom vacuum solutions worldwide, technological perfection, competent advice and reliable service.

COMPLETE RANGE OF PRODUCTS

From a single component to complex systems:

We are the only supplier of vacuum technology that provides a complete product portfolio.

COMPETENCE IN THEORY AND PRACTICE

Benefit from our know-how and our portfolio of training opportunities!

We support you with your plant layout and provide first-class on-site service worldwide.

ed. U - Date 1912 - P/N:PT0203BEN



Are you looking for a
perfect vacuum solution?
Please contact us

Pfeiffer Vacuum GmbH
Headquarters • Germany
T +49 6441 802-0
info@pfeiffer-vacuum.de

www.pfeiffer-vacuum.com

PFEIFFER  **VACUUM**