



Pendulum Control & Isolation Valve with stepper drive actuator

This manual is valid for the valve ordering number(s):

	ISO-F Flange	JIS Flange	ASA-LP Flange
DN63	65036 - P. 52 -	65036 - J. 52 -	65036 - T. 52 -
DN100	65040 - P. 52 -	65040 - J. 52 -	65040 - T. 52 -
DN160	65044 - P. 52 -	65044 - J. 52 -	65044 - T. 52 -
DN200	65046 - P. 52 -	65046 - J. 52 -	65046 - T. 52 -
DN250	65048 - P. 52 -	65048 - J. 52 -	65048 - T. 52 -



Sample photo

The fabrication number is indicated on each product as per the label below (or similar):

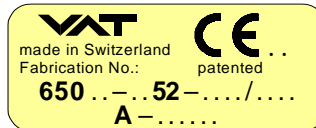

← Fabrication number

Explanation of symbols:



Read declaration carefully before you start any other action!



Keep body parts and objects away from the valve opening!



Attention!



Hot surfaces; do not touch!



Product is in conformity with EC guidelines, if applicable!



Loaded springs and/or air cushions are potential hazards!



Disconnect electrical power and compressed air lines. Do not touch parts under voltage!



Wear gloves!



Read these «**Installation, Operating & Maintenance Instructions**» and the enclosed «**General Safety Instructions**» carefully before you start any other action!



FOR SALES AND SERVICE PLEASE CALL:

PTB SALES T :: 626.334.0500
 service@ptbsales.com
 www.ptbsales.com

DATE SERVICED: _____

VIEW OUR INVENTORY



Contents:

1	Use of product	3
1.1	Technical data	3
2	Installation.....	4
2.1	Unpacking	4
2.2	Installation procedure.....	4
2.2.1	Install valve into system	4
2.2.2	Connect compressed air	7
2.2.3	Connect VAT controller	7
2.2.4	Connect intermediate pumping port.....	7
2.2.5	Connect heating device	7
3	Operation	8
3.1	Normal operation.....	8
3.2	Operation under increased temperature	8
3.3	Behavior in case of compressed air pressure drop.....	8
3.4	Behavior in case of power failure	8
4	Maintenance & repairs	9
4.1	Preventive maintenance procedures.....	10
5	Drawing.....	15
6	Spare parts	16
7	Trouble shooting	18
8	Warranty	19
9	Appendix A – Micro switch configuration of motor driver	20
9.1	For valves with actuator position B1	20
9.2	For valves with actuator position B2	20



1 Use of product

This product is a throttling pendulum valve with isolation functionality. It is intended to use for downstream pressure control applications. Use product for clean and dry indoor vacuum applications under the conditions indicated in chapter «Technical data» only! Other applications are only allowed with the written permission of VAT.

1.1 Technical data

Pressure range at 20°C		
• blank	(650 A52 -)	1 x 10 ⁻⁸ mbar to 1.2 bar (abs)
• hard anodized	(650 H52 -)	1 x 10 ⁻⁶ mbar to 1.2 bar (abs)
Leak rate to outside at 20°C		
• blank	(650 A52 -)	1 x 10 ⁻⁹ mbar ls ⁻¹
• hard anodized	(650 H52 -)	1 x 10 ⁻⁵ mbar ls ⁻¹
Leak rate valve seat at 20°C		
• blank	(650 A52 -)	1 x 10 ⁻⁹ mbar ls ⁻¹
• hard anodized	(650 H52 -)	1 x 10 ⁻⁴ mbar ls ⁻¹
Cycles until first service		
• isolation cycles	(open - closed - open)	200'000 (unheated and under clean conditions)
• throttling cycles	(open - max. throttle - open)	1 Mio. (unheated and under clean conditions)
Compressed air supply		4...7bar (55...100psi)
Admissible operating temperature		
• actuator ambient		35 °C max.
• valve body		10...150 °C
Mounting position		any (valve seat on chamber side is recommended)
Wetted materials		
	valve body, pendulum plate	Aluminum 3.2315 (AA6082)
	sealing ring	Aluminum 3.2315 (AA6082), 1.4306 (304L)
	other parts	1.4435 (316L), 1.4404 (316L), 1.4122, 1.4310 (301), 1.4303 (304), 1.4571
	seals	Viton® (standard). Other materials available. Seal materials are declared on dimensional drawing of specific valve ordering number.
Max. differential pressure on plate during isolation		1200 mbar in either direction

	DN63 / 2.5" _ DN100 / .4" (65036(40) - . . . 52 -)	DN160 / 6" (65044 - . . . 52 -)	DN200 / 8" (65046 - . . . 52 -)	DN250 / 10" (65048 - . . . 52 -)
Max. differential pressure on plate during opening and throttling	30 mbar	10 mbar	5 mbar	5 mbar
Min. controllable conductance (N ₂ molecular flow)	3 ls ⁻¹	5 ls ⁻¹	10 ls ⁻¹	15 ls ⁻¹
Closing time throttling only	0.9 s typ.	1.1 s typ.	1.1 s typ.	1.3 s typ.
Opening time throttling only	0.9 s typ.	1.1 s typ.	1.1 s typ.	1.3 s typ.
Closing time throttling & isolation	3 s typ.	3 s typ.	3 s typ.	3 s typ.
Opening time throttling & isolation	4 s typ.	4 s typ.	4 s typ.	4 s typ.

Operation	Only with VAT Controller (VM-6, PM-6, PM-7 or PM-7E) and VAT connection cable.
Dimensions	Refer to dimensional drawing of specific valve ordering number (available on request).

2 Installation

2.1 Unpacking

As this valve is a heavy component you should lift it with adequate equipment to prevent any injury to humans.



DN200 (8") and DN250 (10") valves are equipped with attachment points (tapped holes). Add eyebolts to these attachment points for lifting. The attachment points are indicated on the dimensional drawing of the specific valve part number (available on request).

Never lay the valve down with actuator downwards as the actuator may be damaged.

2.2 Installation procedure



Fingers and objects must be kept out of the valve opening and away from moving parts. The valve plate may start to move just after power is supplied.



Do not connect or disconnect sensor cable when device is under power.



Do not disconnect air supply when device is under power.

2.2.1 Install valve into system

- Valve seat side should face process chamber. The valve seat side is indicated by the symbol "▽" on the valve flange.
- The valve is a heavy component you should lift it with adequate equipment for installation into system

Note:

- Make sure that enough space is kept free to do preventive maintenance work. The required space is indicated on the dimensional drawing.
- Make sure that the valve is not hanging at screws while installation
- If you use a body flange compl. (S650_DN200, ISO-F) see figure below

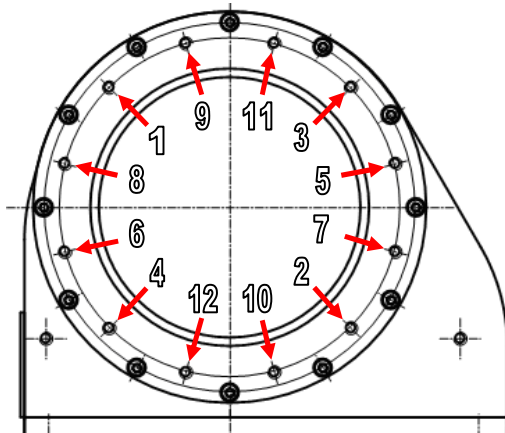

Note:

- Screw in all screws and tighten by hand
- Fasten all screws by numbers from 1 to 12 uniformly step by step, and according with tables on page 5 & 6 (max. tightening torque Nm).



Do not tighten flange screws stronger than indicated in the tables below. The max. tightening torque depends on the type of installation.

Note: Tighten mounting screws of the flanges uniformly in crosswise order. Observe the maximum torque levels in the following tables (a, b + c). Higher tightening torques deforms the valve body and may lead to malfunction of the valve.

a) Mounting with centering ring

Valve size	ISO-F	ISO-F
	max. tightening torque (Nm)	max. tightening torque (lbs . ft)
DN63 / 2.5" (65036 - . . 52 -)	8 – 10	6 - 8
DN100 / 4" (65040 - . . 52 -)	8 – 10	6 - 8
DN160 / 6" (65044 - . . 52 -)	13 – 15	9 - 11
DN200 / 8" (65046 - . . 52 -)	13 – 15	9 - 11
DN250 / 10" (65048 - . . 52 -)	17 – 20	13 – 15
	hole depth (mm)	hole depth (inch)
DN63 / 2.5" (65036 - . . 52 -)	12	0.47
DN100 / 4" (65040 - . . 52 -)	12	0.47
DN160 / 6" (65044 - . . 52 -)	14	0.55
DN200 / 8" (65046 - . . 52 -)	15	0.59
DN250 / 10" (65048 - . . 52 -)	16	0.63

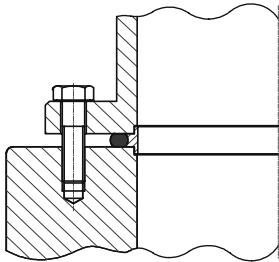

Note: Use slightly lubricated screws and make sure that screws are not too long otherwise the valve body may be damaged. Refer to chapter «Spare parts» for centering ring ordering numbers.

b) Mounting with O-ring in groove

Valve size	ISO-F	JIS	ASA-LP	ISO-F	JIS	ASA-LP
	max. tightening torque (Nm)			max. tightening torque (lbs . ft)		
DN63 / 2.5" (65036 - . . 52 -) DN100 / 4" (65040 - . . 52 -)	20-23	35-40	35-40	15 - 17	26 - 30	26 - 30
DN160 / 6" (65044 - . . 52 -)	35-40	35-40	35-40	26 - 30	26 - 30	26 - 30
DN200 / 8" (65046 - . . 52 -)	35-40	35-40	80-90	26 - 30	26 - 30	59 - 67
DN250 / 10" (65048 - . . 52 -)	35-40	65-70	80-90	26 - 30	48 - 52	59 - 67
	hole depth (mm)			hole depth (inch)		
DN63 / 2.5" (65036 - . . 52 -) DN100 / 4" (65040 - . . 52 -)	12	12	12	0.47	0.47	0.47
DN160 / 6" (65044 - . . 52 -)	14	14	14	0.55	0.55	0.55
DN200 / 8" (65046 - . . 52 -)	15	15	14	0.59	0.59	0.59
DN250 / 10" (65048 - . . 52 -)	16	16	16	0.63	0.63	0.63

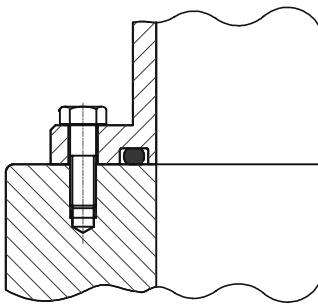

Note: These torques are valid if depth of the mounting screws is min. 1 x thread diameter. Make sure that screws in use are capable to withstand applied torques. Also use slightly lubricated screws and make sure that screws are not too long otherwise the valve body may be damaged.



Do not admit higher forces to the valve than indicated in the table below.

c) Admissible forces

Forces from evacuating the system, from the weight of other components, and from baking can lead to deformation and malfunctioning of the valve. Stress has to be relieved by suitable means, e.g. bellows sections.

Valve size	Axial tensile or compressive force «F _A »		Bending moment «M»	
	N	lb.	Nm	lbf.
DN63 / 2.5" (100 / 4") (65036(40) - . . 52 -)	1000	220	40	30
DN160 / 6" (65044 - . . 52 -)	2000	440	80	60
DN200 / 8" (65046 - . . 52 -)	2000	440	80	60
DN250 / 10" (65048 - . . 52 -)	2500	550	100	75

For a combination of both forces (F_A and M) the values are invalid.
 Verify that the depth of the mounting screws is min. 1 x thread diameter.
 Please contact VAT for more information.

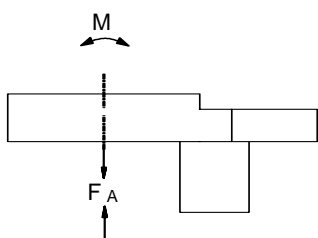



2.2.2 Connect compressed air



Compressed air pressure (above ATM) must be in the range of: 4 - 7 bar / 55 - 100 psi. Use only clean, dry or slightly oiled air.

- Connect compressed air **supply** to actuator connection labeled '**IN**'
- Connect compressed air **return line** to actuator connection labeled '**OUT**'
- IN / OUT connections are 1/8" ISO/NPT internal threads. Refer to Figure 1.

2.2.3 Connect VAT controller

- The VAT controller has to be turned off for at least 60 seconds before connecting/disconnecting it to/from the valve.
- Connect valve to VAT controller (650PM - or 650VM -) by using the VAT connection cable (650CV-99L . . .). Refer to Figure 1.
- Install VAT Controller according to the manual of the controller.

2.2.4 Connect intermediate pumping port

- This valve has a double sealed rotary feed through with intermediate pumping port for the actuator. Refer to drawing on page 15.
- Optional: Connect vacuum line to this intermediate pumping port (1/8" ISO/NPT). Refer to Figure 2.

2.2.5 Connect heating device

This valve may be optionally equipped with a heating device. Connect VAT heating device according to manual of the heating device.

IN: compressed air supply
OUT: return line



Figure 1

intermediate
pumping port



Figure 2

3 Operation



Operation is allowed after completion of the installation procedure only.

3.1 Normal operation

This valve may be operated only with a VAT controller and a VAT cable. For operation details other than those mentioned below refer to the manual of the VAT controller.

Do not operate the valve if the differential pressure between both valve sides is higher than the value specified in chapter «Technical data». Otherwise the valve may be damaged and malfunction is caused.

3.2 Operation under increased temperature

Refer to chapter «Technical data»

3.3 Behavior in case of compressed air pressure drop

Valve position before compressed air pressure drop:	Reaction of valve:
Valve closed	Valve remains closed.
Valve open or in any intermediate position	Sealing ring moves down and blocks the pendulum plate at the current position. VAT controller with display indicates ‚COMPRESSED AIR FAILURE‘. Refer to the manual of the VAT controller for details.

3.4 Behavior in case of power failure

Valve position before power failure:	Reaction of valve:	
	When operated by a VAT Controller with Power Failure Option	When operated by a VAT Controller without Power Failure Option
Valve closed	Valve remains closed. VAT controller with display indicates ‚POWER FAILURE‘. Refer to the manual of the VAT controller for details.	Valve remains closed.
Valve open or in any intermediate position	Valve will close *) VAT controller with display indicates ‚POWER FAILURE‘. Refer to the manual of the VAT controller for details.	Sealing ring moves down and blocks the pendulum plate at the current position.

*) Provided that the battery pack of the VAT controller is charged, refer to the manual of the VAT controller for details.



4 Maintenance & repairs

Under clean operating conditions, the valve does not require any maintenance during the specified cycle life. Contamination from the process may influence the function and requires more frequent maintenance.

Before carrying out any maintenance or repairs, please contact VAT. It has to be individually decided whether the maintenance/repair can be performed by the customer or has to be carried out by VAT. The fabrication number on the valve

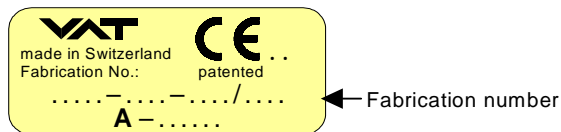

has always to be specified.

All supplies (e. g. compressed air, electrical power) must be disconnected for removal/installation of the valve from/into the system and for maintenance work.



Even with disconnected supply, loaded springs and/or air cushions in cylinders can be potential hazards.



Keep fingers and objects away from the valve opening!

Products returned to VAT must be free of harmful substances such as e.g. toxic, caustic or microbiological ones. If products are radioactively contaminated, fill in the VAT form «Contamination and Radiation Report» and send it with the product. The form is available at VAT. The maximum values indicated in the form must not be exceeded.

4.1 Preventive maintenance procedures



Keep fingers out of the valve body during preventive maintenance work. The sealing ring or its retaining pins will lower in case of electrical power failure or loss of compressed air.



Take precautions to protect yourself from harmful substances that may have contaminated the valve during use.

Two preventive maintenance procedures are defined for this valve. These are:

- **Replacement of isolation seals** (gate and body seal of sealing ring) **and valve cleaning**
- **Replacement of actuator shaft seals**

Required frequency of cleaning and replacement of seals is depending on process conditions.



A critical factor influencing the maintenance period is the lifetime of the vacuum grease, being limited under increased temperature. In this case grease will separate to PTFE and oil. The oil may flow and contaminate the valve parts.

VAT can give the following **recommendations for preventive maintenance**:

	unheated *)	heated ≤ 80°C *)	heated > 80°C *)
isolation seals (gate and body seal of sealing ring)	200'000 cycles	6 months	3 months
actuator shaft seals	1 Mio. cycles	6 months	3 months

*) These figures are reference values for clean conditions under various temperatures. These values do not include any impact of the process. Therefore preventive maintenance schedule has finally to be checked for the actual process conditions.



Prevent gap between body and sealing ring from air gun cleaning. Otherwise vacuum grease may be distributed and contaminate the valve.

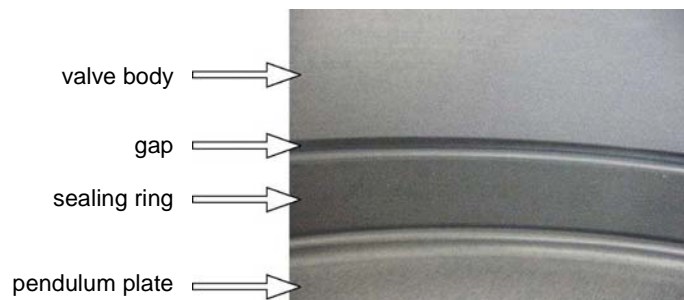







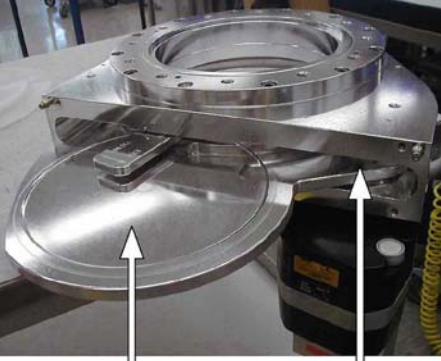
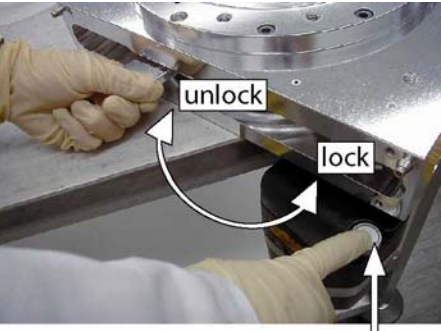

Installation, Operating & Maintenance Instructions
Series 650, DN 63-250 (I.D. 2.5"-10")

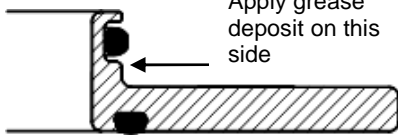

Replacement of isolation seals (gate and body seal of sealing ring) and valve cleaning

Replacement of actuator feed through seals

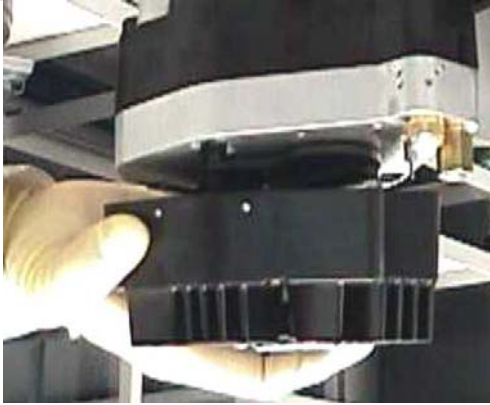
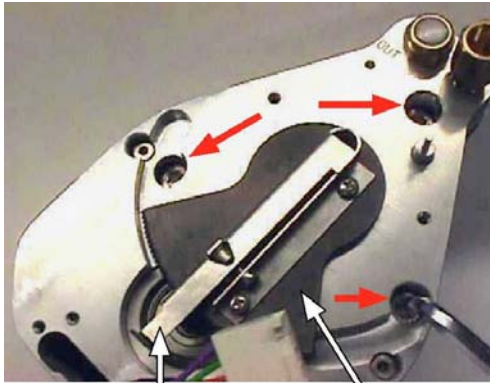
Description		Required tool
<ol style="list-style-type: none"> Vent both valve chambers. Open bonnet screws and remove valve bonnet. 		<p>Allen wrench 5mm</p>
<ol style="list-style-type: none"> Give 'OPEN' command on VAT controller to bring pendulum plate to OPEN position. Caution: Stand away from valve – pendulum plate moves out of the valve body. To prevent the pendulum plate from moving during work, switch the VAT controller to maintenance mode. Refer to the manual of the VAT controller for details. Unfasten mounting screw for pendulum plate. Remove pendulum plate. 	 <p>pendulum plate mounting screw for pendulum plate</p>	<p>open end wrench 13mm</p>
<ol style="list-style-type: none"> With one hand press the MAINTENANCE BUTTON to lower the sealing ring, with your second hand unlock the sealing ring by pressing the handle. Release MAINTENANCE BUTTON. Remove sealing ring. 	 <p>unlock lock</p> <p>maintenance button</p>	

Description	Required tool											
<p>10. Remove gate and body o-ring from sealing ring carefully with a soft tool.</p> <p>11. Remove grease residues at sealing ring with alcohol. Clean sealing ring and pendulum plate with alcohol or in an ultrasonic bath.</p> <p>12. Clean out valve body with alcohol. Use an appropriate non metal tool with a cloth to enter valve body. Do not enter valve body with hands! Then blow out valve body with clean air. Do not directly expose seals (actuator and retaining pin see-through) to air stream!</p> <p>13. Clean or replace gate seal if necessary. Install gate o-ring to sealing ring without grease.</p>												
<p>14. Clean or replace body seal if necessary. Lubricate body o-ring with the quantity of vacuum grease listed in the table to the right.</p>	<table border="1"> <thead> <tr> <th>Valve size</th> <th>Quantity of grease [ml]</th> </tr> </thead> <tbody> <tr> <td>DN63 / 2.5" (100 / 4") (65036(40) - . . . 52 -)</td> <td>0.1</td> </tr> <tr> <td>DN160 / 6" (65044 - . . . 52 -)</td> <td>0.15</td> </tr> <tr> <td>DN200 / 8" (65046 - . . . 52 -)</td> <td>0.2</td> </tr> <tr> <td>DN250 / 10" (65048 - . . . 52 -)</td> <td>0.2</td> </tr> </tbody> </table>	Valve size	Quantity of grease [ml]	DN63 / 2.5" (100 / 4") (65036(40) - . . . 52 -)	0.1	DN160 / 6" (65044 - . . . 52 -)	0.15	DN200 / 8" (65046 - . . . 52 -)	0.2	DN250 / 10" (65048 - . . . 52 -)	0.2	
Valve size	Quantity of grease [ml]											
DN63 / 2.5" (100 / 4") (65036(40) - . . . 52 -)	0.1											
DN160 / 6" (65044 - . . . 52 -)	0.15											
DN200 / 8" (65046 - . . . 52 -)	0.2											
DN250 / 10" (65048 - . . . 52 -)	0.2											
<p>15. Install body o-ring into sealing ring.</p>												
<p>16. Deposit vacuum grease on the bottom side of the body seal according to drawing below. Pay attention that the quantity of vacuum grease listed in the table to the right is distributed constantly over the whole circumference.</p>	<table border="1"> <thead> <tr> <th>Valve size</th> <th>Quantity of grease [ml]</th> </tr> </thead> <tbody> <tr> <td>DN63 / 2.5" (100 / 4") (65036(40) - . . . 52 -)</td> <td>0.2</td> </tr> <tr> <td>DN160 / 6" (65044 - . . . 52 -)</td> <td>0.25</td> </tr> <tr> <td>DN200 / 8" (65046 - . . . 52 -)</td> <td>0.3</td> </tr> <tr> <td>DN250 / 10" (65048 - . . . 52 -)</td> <td>0.4</td> </tr> </tbody> </table>	Valve size	Quantity of grease [ml]	DN63 / 2.5" (100 / 4") (65036(40) - . . . 52 -)	0.2	DN160 / 6" (65044 - . . . 52 -)	0.25	DN200 / 8" (65046 - . . . 52 -)	0.3	DN250 / 10" (65048 - . . . 52 -)	0.4	
Valve size	Quantity of grease [ml]											
DN63 / 2.5" (100 / 4") (65036(40) - . . . 52 -)	0.2											
DN160 / 6" (65044 - . . . 52 -)	0.25											
DN200 / 8" (65046 - . . . 52 -)	0.3											
DN250 / 10" (65048 - . . . 52 -)	0.4											
												

Description		Required tool	
<p>17. Turn off the VAT controller. Wait for 60s, then disconnect cable and compressed air from valve actuator.</p> <p>18. Unfasten all 4 motor driver screws and lift motor driver carefully from actuator. Then separate actuator from motor driver by disconnecting the cable carefully.</p> <p>19. Turn the cog wheel manually to the middle position. Caution: Push the cog wheel, not the position indicator finger.</p> <p>20. Unfasten all 3 actuator screws and remove actuator.</p>	  <p style="text-align: center;">position indicator finger cog wheel</p>	<p>Allen Wrench 3 mm</p> <p>Allen Wrench 5 mm</p>	
<p>21. Remove seals from actuator feed through carefully with a soft tool.</p> <p>22. Clean actuator feed through with alcohol.</p> <p>23. Lubricate each o-ring groove with 0.1 ml vacuum grease. Pay attention that grease is distributed constantly over the whole circumference.</p>			

Description		Required tool										
<p>24. Clean or replace seals if necessary. Lubricate each o-ring with 0.05 ml vacuum grease.</p> <p>25. Install o-rings.</p> <p>26. Deposit 0.1 ml vacuum grease on each o-ring. Pay attention that grease is distributed constantly over the whole circumference.</p>												
<p>27. Remove fixation kit and mounting screw for pendulum plate.</p> <p>28. Clean screw and slightly lubricate thread. Then reinstall fixation kit.</p> <p>29. Clean actuator shaft and lubricate it with 0.1 ml vacuum grease.</p>												
<p>30. Install actuator and motor driver in reverse order as they had been disassembled (steps 20 to 17).</p> <ul style="list-style-type: none"> • Tighten actuator screws with 6 Nm. • Remove vacuum grease from actuator shaft face after installation. • Check micro switch configuration of motor driver (refer to Appendix A – Micro switch configuration of motor driver) and make sure that cable between actuator and motor driver is connected correctly. • Tighten motor driver screws with 3 Nm. 	 <p style="text-align: center;">micro switch</p>	<p>Allen Wrench 3 mm</p> <p>and</p> <p>Allen Wrench 5mm</p>										
<p>31. Install sealing ring and pendulum plate in reverse order as they had been disassembled (steps 9 to 5).</p> <p>32. Mount valve bonnet.</p> <ul style="list-style-type: none"> • Tightening torques for bonnet screws are listed in the table to the right. 	<table border="1"> <thead> <tr> <th>Valve size</th> <th>Max. torque [Nm]</th> </tr> </thead> <tbody> <tr> <td>DN63 / 2.5" (100 / 4") (65036(40) - . . . 52 -)</td> <td>6</td> </tr> <tr> <td>DN160 / 6" (65044 - . . . 52 -)</td> <td>6</td> </tr> <tr> <td>DN200 / 8" (65046 - . . . 52 -)</td> <td>6</td> </tr> <tr> <td>DN250 / 10" (65048 - . . . 52 -)</td> <td>6</td> </tr> </tbody> </table>	Valve size	Max. torque [Nm]	DN63 / 2.5" (100 / 4") (65036(40) - . . . 52 -)	6	DN160 / 6" (65044 - . . . 52 -)	6	DN200 / 8" (65046 - . . . 52 -)	6	DN250 / 10" (65048 - . . . 52 -)	6	<p>Allen wrench 5mm</p> <p>and</p> <p>open end wrench 13mm</p>
Valve size	Max. torque [Nm]											
DN63 / 2.5" (100 / 4") (65036(40) - . . . 52 -)	6											
DN160 / 6" (65044 - . . . 52 -)	6											
DN200 / 8" (65046 - . . . 52 -)	6											
DN250 / 10" (65048 - . . . 52 -)	6											

5 Drawing

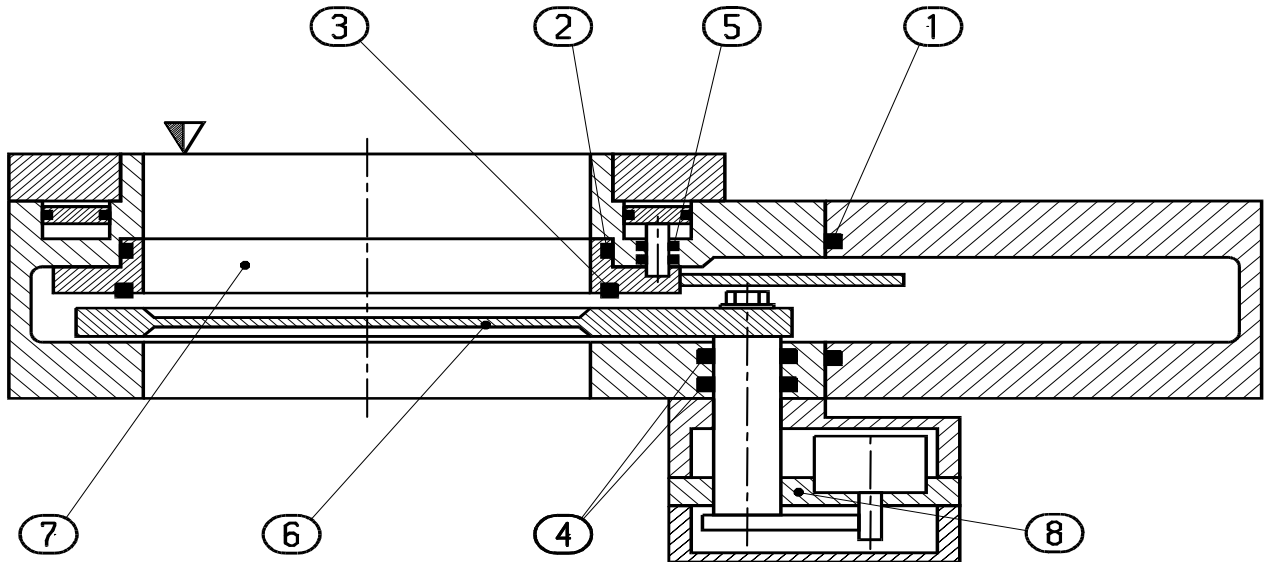



6 Spare parts



Please specify the **fabrication number of the valve** (see yellow label on valve) when ordering spare parts. This is to ensure that the appropriate spare parts are supplied.

Item	Description		DN63 / 2.5" (100 / 4") (65036(40) - . . . 52 -)	DN160 65044 - . . . 52 -	DN200 65046 - . . . 52 -	DN250 65048 - . . . 52 -
1	Bonnet seal	Viton	N-5100-259	N-5100-267	N-5100-272	N-5100-277
		other materials	on request	on request	on request	on request
2	Body seal (Viton) This includes a 2ml syringe of vacuum grease		204884	206527	200468	202592
3	Gate seal	Viton	N-5100-155	N-5100-258	N-5100-266	N-5100-275
		other materials	on request	on request	on request	on request
	Seal kit vacuum (Viton). This consists of item 2 and 3.		204883	206526	204204	203883
	Syringe of vacuum grease	2ml	206792			
		5ml	206793			
4	Actuator shaft seals (Viton)		N-5111-329 (2 pcs required per valve)			
5	Sealing ring shaft seals (Viton)		N-5111-112 (12 pcs required per valve)	N-5111-112 (8 pcs required per valve)	N-5111-112 (12 pcs required per valve)	N-5111-112 (16 pcs required per valve)
6	Pendulum plate:					
	- Blank	B1 *)	91048-01	101570-01	201272	94632-01
	- Blank	B2 *)	on request	231343	226661	on request
	- Hardanodized	B1 *)	100741-01	98371-01	200500	92228-01
	- Hardanodized	B2 *)	226810	98673-01	201437	92229-01
	- Nickel coated	B1 *)	91048-01	on request	211613	on request
	- Nickel coated	B2 *)	on request	on request	on request	on request
	- Stainless steel	B1 *)	on request	on request	205296	not available
7	Sealing ring					
	- Blank		216490	207518	204453	205874
	- Hardanodized		217050	204340	202046	203217
	- Nickel coated		241368	on request	211610	on request
	- Stainless steel		on request	on request	205417	not available
8	Actuator complete (incl. motor driver)	B1 *)	235154			
		B2 *)	235155			
	ISO-F centering ring with Viton o-ring for installation	Aluminum	32040-QAZV	32044-QAZV	32046-QAZV	32048-QAZV
		Stainless steel	32040-QEZV	32044-QEZV	32046-QEZV	32048-QEZV

The item numbers refer to the drawing on page 15

Note: Use only spare parts manufactured by VAT to assure safe and reliable operation!

*) Refer to figures on next page to check for actuator position options.



Actuator position options:

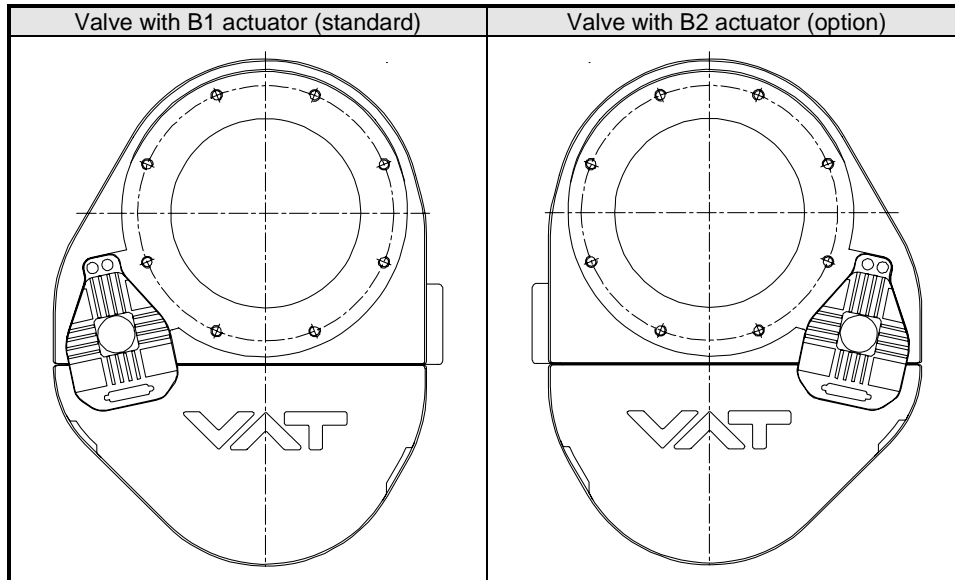



7 Trouble shooting

Failure	Check	Action
Valve does not close/open/control	VAT connection cable (controller to valve) connected correctly?	Connect cable to controller and valve
	Power for VAT controller supplied?	Connect VAT controller to power supply or mains respectively. Check if mains switch is on if present. For details refer to manual of VAT controller.
	Compressed air pressure supplied for valve?	Connect compressed air to valve. Refer to «2.2 Installation procedure» for details.
Pressure / position control does not work	Setup of VAT controller done correctly?	Refer to manual of VAT controller for details.
	Correct operation mode selected?	Refer to manual of VAT controller for details.
	Pressure gauge installed, setup correct and connected to VAT controller?	Refer to manual of pressure gauge and VAT controller for details.
Leak at gate	Sealing area contaminated?	Clean pendulum plate and sealing ring.
	Sealing surfaces of pendulum plate or/and sealing ring damaged?	Replace damaged part. Refer to «4.1 Preventive maintenance procedures».
	Sealing surfaces on valve body damaged?	Please contact your VAT service center for repair.
	O-rings on sealing ring damaged or not installed correctly?	Install o-ring correctly. Replace it if necessary. Refer to «4.1 Preventive maintenance procedures».
Leak to outside	Flanges leaktight? Sealing surface or flange seal damaged?	Verify if valve is installed correctly according to «2.2.1 Install valve into system» and admissible forces are not exceeded. Replace o-ring if necessary. Please contact a VAT service center for repair if flange sealing surface of valve is damaged.
	Valve bonnet leaktight?	Verify if bonnet screws are tightened with correct torque (see page 14). Replace bonnet seal if necessary.
	Actuator feedthroughs leaktight?	Perform His leak check at intermediate pumping port of actuator (see Figure 2 on page 7). Replace seals according to «4.1 Preventive maintenance procedures» if necessary.
	Leak at sealing ring shaft seals of retaining pins.	Please contact a VAT service center for repair.

If you need any further information, please contact one of our service centers. You can find the addresses on our website: <http://www.vat.ch>



8 Warranty

Each product sold by VAT Vakuumventile AG (VAT) is warranted to be free from the manufacturing defects that adversely affect the normal functioning thereof during the warranty period stated in VAT's «Terms of Sale» immediately following delivery thereof by VAT, provided that the same is properly operated under conditions of normal use and that regular, periodic maintenance and service is performed or replacements made, in accordance with the instructions provided by VAT. The foregoing warranty shall not apply to any product or component that has been repaired or altered by anyone other than an authorized VAT representative or that has been subject to improper installation or abuse, misuse, negligence or accident. VAT shall not be liable for any damage, loss, or expense, whether consequential, special, incidental, direct or otherwise, caused by, arising out of or connected with the manufacture, delivery (including any delay in or failure to deliver), packaging, storage or use of any product sold or delivered by VAT shall fail to conform to the foregoing warranty or to the description thereof contained herein, the purchaser thereof, as its exclusive remedy, shall upon prompt notice to VAT of any such defect or failure and upon the return of the product, part or component in question to VAT at its factory, with transportation charges prepaid, and upon VAT's inspection confirming the existence of any defect inconsistent with said warranty or any such failure, be entitled to have such defect or failure cured at VAT's factory and at no charge therefor, by replacement or repair of said product, as VAT may elect. VAT MAKES NO WARRANTY OR REPRESENTATION OF ANY KIND, EXPRESS OR IMPLIED, (INCLUDING NO WARRANTY OR MERCHANTABILITY), EXCEPT FOR THE FOREGOING WARRANTY AND THE WARRANTY THAT EACH PRODUCT SHALL CONFORM TO THE DESCRIPTION THEREOF CONTAINED HEREIN, and no warranty shall be implied by law.

Furthermore, the «Terms of sale» at the back of the price list are applicable.

9 Appendix A – Micro switch configuration of motor driver

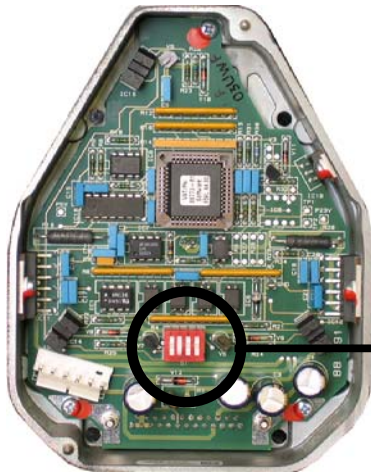

The black point (●) means:
«Push down»

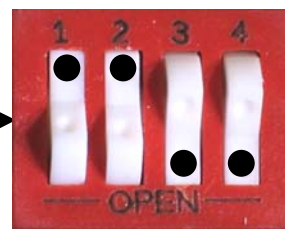

Micro switch S1
 (example)

9.1 For valves with actuator position B1

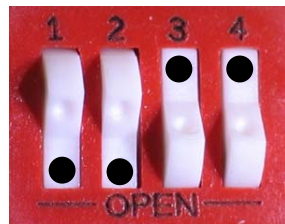
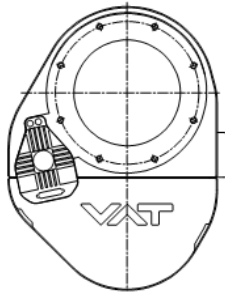

Switch position for:

- DN63
- DN100

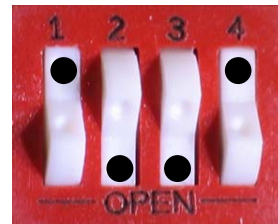

Switch position for:

- DN160
- DN200

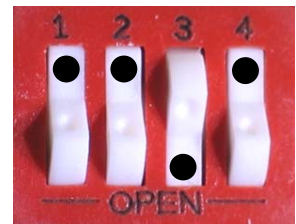

Switch position for:

- DN250

9.2 For valves with actuator position B2

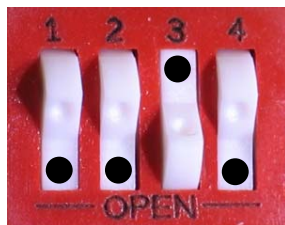
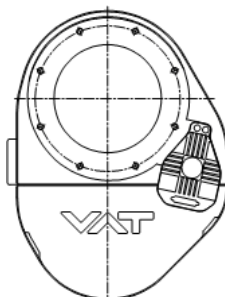

Switch position for:

- DN63
- DN100



Switch position for:

- DN160
- DN200

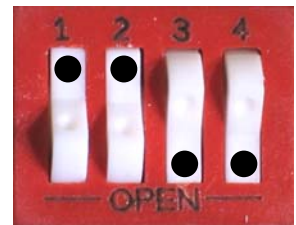

Switch position for:

- DN250