



## Adaptive Pressure Controller PM-4 & 5 for Gate Valve Control System

This manual is valid for product with the product identification number

FABR. NO. 641PM - . 6 . . . . .

configured with Software Version

64PM.3I.00

PM-5



PM-4



The product identification is specified on the rear panel of each PM controller:



STOP

Read these «**Installation, Operating and Maintenance Instructions**» (IOMI) and the enclosed «**General Safety Instructions**» carefully before you start any other action.

### Table of content

1	Intended Use of Product .....	2
1.1	Technical Data .....	2
2	Installation .....	2
2.1	Content of VAT PM Controller Delivery ..	2
2.2	Hardware Installation .....	2
2.3	PM Configuration (setup sequence) .....	4
3	Operation .....	5
3.1	Local Mode (PM-4 with Service Box only) ..	5
3.2	Remote Mode (PM-5 if Interface installed only) .....	5
3.3	Power Failure / Power Failure Option (PFO).....	5
4	Preventive Maintenance .....	6
5	Spare Parts / Retrofit Options .....	7
6	Trouble Shooting .....	7
7	Repairs.....	8
8	Warranty .....	8
9	Engineering Information.....	9
9.1	Wiring of Connectors .....	9
9.2	RS232C Interface Configuration.....	13
9.3	RS232C Communication.....	13
9.4	User Information and Recommendations.....	17



FOR SALES AND SERVICE PLEASE CALL:

**PTB SALES** T :: 626.334.0500  
service@ptbsales.com  
www.ptbsales.com

DATE SERVICED: \_\_\_\_\_

VIEW OUR INVENTORY

## 1 Intended Use of Product

This product is an adaptive pressure controller for VAT series 64 control valves. The product may only be operated within the ranges specified below:

### 1.1 Technical Data

Mains voltage	100 - 240 VAC (±10%), 50/60 Hz
Temperature	0 - 50 °C
Sensor input signal	0 - 10 VDC max.
Sensor power supply	+ 15 VDC (±5%), 1400 mA max. (total current for sensor 1 and 2) - 15 VDC (±5%), 1400 mA max. (total current for sensor 1 and 2)
Operation	only with VAT series 64 control valve

Additional technical information see chapter 'Engineering Information'

## 2 Installation

### 2.1 Content of VAT PM Controller Delivery

- Adaptive Pressure Controller PM-4 or PM-5
- Plug for mains connection of controller
- Plug for interface cable
- Plug for cable of pressure sensor 1 (standard) and 2 (option)

### 2.2 Hardware Installation

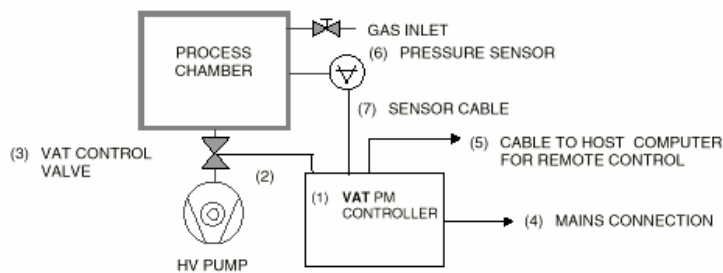

picture 1: hardware for pressure control



## Installation, Operating, and Maintenance Instructions Series 64.1

---

### Confirm that hardware is complete (picture 1)

- (1) Adaptive Pressure Controller PM-4 or PM-5, hereafter referred to as PM controller.  
For PM controller with power failure option confirm that battery life has not expired (see chapter ,4 Preventive Maintenance')
- (2) Connection cable valve - PM controller: VAT part number 640CV-99L .
- (3) VAT Series 64 control valve
- (4) Mains connection, wiring information see chapter ,9.1.2 Connector for mains'
- (5) Interface cable, wiring information see chapter ,9.1.3 Connector for interface'
- (6) Sensor 1 (standard) and 2 (option)
- (7) Cable for sensor 1 and 2, wiring information see chapter ,9.1.1 Connector for sensor 1 and sensor 2'

### Install hardware



PM controller must be switched off during installation.

- Install VAT control valve (3) according to the Installation, Operating and Maintenance Instruction Manual of the VAT Series 64 control valve.
- Install sensor(s) (6) according to the recommendations of the sensor manufacturer
- Install PM controller (1) into control rack.
- Connect valve cable (2) to control valve and then to PM controller (connector: valve)
- Connect sensor cable (7) to sensor(s) and then to PM controller (connector: sensor 1 / sensor 2)
- For remote operation, connect interface cable (5) to PM controller (connector: interface)
- Connect mains cable (4) to PM controller

### 2.3 PM Configuration (setup sequence)

STEP		LOCAL MODE (PM-4 in combination with Service Box only)	REMOTE MODE (PM-5 if interface installed only)
1	<b>POWER ON</b>	<ol style="list-style-type: none"> <li>PM controller: Turn on power switch at the rear panel of the PM controller. <b>Note:</b> Valve will close, if not in closed position</li> <li>On PM-5 or Service Box start-up display (Software version, type of interface, etc.) appears, until valve is in closed position</li> <li>CLOSE(D) is displayed, otherwise please refer to chapter '6 Trouble Shooting'.</li> </ol>	
2	<b>SELECT MODE</b>	Select LOCAL operation by pressing «LOCAL» key for 2 seconds.	Select REMOTE operation by pressing «REMOTE» key on front panel or Service Box for 2 seconds <b>or</b> select remote operation through RS232 (see ,9.3.1 Control commands') or logic interface (see ,9.1.3.1 Logic interface')
3	<b>AUTOMATIC SIZE ADJUSTMENT</b>	Press simultaneously «OPEN» and «CLOSE» keys for 2 seconds. The controller will perform an automatic size adjustment procedure to determine open and closed position and the range between the two positions.	Send RS232 command: <b>J:&lt;CR&gt;&lt;LF&gt;</b> (see ,9.3.1 Control commands') or use Logic command (see ,9.1.3.1 Logic interface')
4	<b>SENSOR SETUP<sup>1)</sup></b>	Press simultaneously «LEARN» and «ZERO» key for 2 seconds (notation used hereafter: «&», e.g. «LEARN» & «ZERO»). Then, use «↑» and «↓» key to change parameters (VOLTAGE RANGE; DISPLAY RANGE; DISPLAY UNIT; GAIN FACTOR; SENSOR TYPE; ZERO ADJUST) for each sensor. Toggle with «F1» key to the next setup parameter. Press «F2», when finished.	See ,9.3.3 Sensor setup command' Example: Sensor 1, Voltage Range: 0-10V; Display Range: 0-10; Display Unit: Torr; Gain Factor: 1; Sensor Type: Torr; Zero Adjust: enabled; <b>s:1332010&lt;CR&gt;&lt;LF&gt;</b> Mind: Not possible to do by a logic interface.
5	<b>ZERO ADJUST</b> (Offset compensation of sensor output)	Evacuate process chamber to high vacuum. When the base pressure is reached, press «ZERO» key for 2 seconds to reset the offset of the pressure sensor. Disable ZERO function in SENSOR SETUP, if the base pressure of your system is higher than 1‰ of sensor full scale.	Evacuate process chamber to high vacuum. When the base pressure is reached send RS232 command: <b>Z:&lt;CR&gt;&lt;LF&gt;</b> (see ,9.3.1 Control commands') or use Logic command (see ,9.1.3.1 Logic interface'). Disable ZERO function in SENSOR SETUP, if the base pressure of your system is higher than 1‰ of sensor full scale.
6	<b>LEARN<sup>2)</sup></b> (Determination of control characteristics of your process chamber)	Process chamber at high vacuum, control valve is open: Open gas inlet and set gas flow (see recommendation below). Press «LEARN» key for 3 seconds to perform the autolearning routine of the PM controller. The autolearning routine may take several minutes and can be aborted by pressing the «F1» key. A single full run of the autolearning routine is required to ensure fast and accurate pressure control. <b>Note:</b> It is not necessary to repeat LEARN, if the sensor setup is changed, or if the second sensor is selected for pressure control. The controller covers 5% to 5000% of the gasflow which was used at LEARN.	Process chamber at high vacuum, control valve is open: Open gas inlet and set gas flow (see recommendation below). Then send RS232 LEARN command: <b>L:001000&lt;CR&gt;&lt;LF&gt;</b> (,9.3.1 Control commands') or Logic command (see ,9.1.3.1 Logic interface'). The autolearning routine may take several minutes. A single full run of the autolearning routine is required to ensure fast and accurate pressure control. <b>Note:</b> It is not necessary to repeat LEARN, if the sensor setup is changed, or if the second sensor is selected for pressure control. The controller covers 5% to 5000% of the gasflow which was used at LEARN.

**Legend:**

- 1) The default **GAIN FACTOR** is 1.00. See chapter ,9.3.3 Sensor setup command' if resetting is necessary.
- gain factor > 1 means: faster control but higher overshoot of pressure
  - gain factor < 1 means: slower control but lower overshoot of pressure
- Just 98% of sensor pressure range can be used during control.  
If no sensor is used, select as display parameter 'POS'.

- 2) Ideal gasflow for autolearning

$$Q = 40 \cdot p_{SFS} \cdot L_{min}$$

Q.....gasflow for autolearning [scm]  
 p<sub>SFS</sub>.....sensor full scale pressure [Torr]  
 L<sub>min</sub> .....min. controllable conductance [l/s]



Do not use a different gasflow than recommended for autolearning otherwise pressure control performance may be insufficient.

valve size	DN63	DN100	DN160	DN200	DN250	DN320	DN400
min. controllable conductance	0.6 l/s	1 l/s	1.6 l/s	2 l/s	2.5 l/s	3.2 l/s	4 l/s



## 3 Operation

For user information and recommendations for pressure control please refer to ch0r '9.4 User Information and Recommendations'

### Display Information: (PM-4 with Service Box only)

'P1:/'P2:' for actual pressure, 'SP:' for set point pressure, 'Pos:' for valve position (0000 = closed, 1000 = open)

#### Errors:

'E' on display for position error, 'P' for parameter error (refer to section '6 Trouble Shooting')

#### Power-fail option:

'D', if power-fail option disabled temporarily (only in local mode possible)

#### Logic Inputs:

'M', if Logic Inputs disabled by RS232C command

### 3.1 Local Mode (PM-4 with Service Box only)

#### Activate keyboard:

Press «LOCAL» key for 2 seconds to enable keyboard. LED on «LOCAL» key will turn green.

#### Open valve:

Press «OPEN». LED on «OPEN» key will turn green.

#### Close valve:

Press «CLOSE». LED on «CLOSE» key will turn green.

#### Select sensor: (for double sensor version)

Press «F2» & «↑» key to toggle between sensor 1 and sensor 2. As an alternative, the sensor setup may be used to select the sensor for pressure control.

#### Pressure control:

Press «PRESSURE MODE» key, then press one of the four «SET POINT» keys. Use «↑» or «↓» key to change set point value. Store the set point value by pressing one of the four «SET POINT» keys for at least 2 seconds.

#### Freeze valve position, interrupt pressure control:

While in PRESSURE MODE, press «F1» key to interrupt pressure control and freeze the actual valve position. 'HOLD' will appear on display. Press «PRESSURE MODE» key to continue pressure control.

#### Valve position control:

Press «POSITION MODE», then press one of the four «SET POINT» keys. Use «↑» or «↓» key to change the position value. Store set point value by pressing «SET POINT» key for at least 2 seconds.

**Note:** Commands «ZERO», «LOCAL», «REMOTE», «LEARN», «F1» & «F2» require that the keys are pressed for 2 seconds, before the commands are accepted to prevent that the settings are changed accidentally.

**Contrast of the display** can be adjusted by pressing «F1» & «F2» & «↑», or «F1» & «F2» & «↓» key.

### 3.2 Remote Mode (PM-5 if Interface installed only)

Press «REMOTE» key for 2 seconds or select remote operation through RS 232C or LOGIC interface for remote control. For details about interface wiring and remote commands refer to chapter '9 Engineering Information'.

### 3.3 Power Failure / Power Failure Option (PFO)

All parameters will remain stored during a power failure.

If a power-fail battery is installed (check VAT part number of PM controller: 641PM- . 6B . - . . . .), the PM controller has to be hooked up to power for at least 10 hours to assure repeated valve closures in case of a power failure.

**Note:** By pressing the «F2» key for 2 seconds, the **Power Fail Option** will be **disabled** for 1 minute. A 'D' will be displayed on the control panel.

## 4 Preventive Maintenance



### ESD Precaution!

All work on the controller has to be done under ESD protected environment to prevent electronic components from damage!

**SRAM** (see chapter ,5 Spare Parts / Retrofit Options' part number.)

When the battery life expires (typical lifetime is 5 years, check date specified on label on the rear panel of PM controller), the SRAM memory needs to be exchanged.

Procedure:

- Turn off power to PM controller, disconnect power cable and wait for 60 seconds.
- Disconnect sensor cable, valve cable and interface cable.
- Open top cover of PM controller.
- Exchange SRAM (IC3 on master board), confirm SRAM is installed correctly. Check mark for pin 1 [O] on SRAM. First row of socket contacts must be left empty.
- Reattach cover.
- Attach label with new expiration date on back panel of PM controller.
- Perform PM configuration routine  
 (SENSOR SETUP, AUTO SIZE ADJUST, ZERO, LEARN).

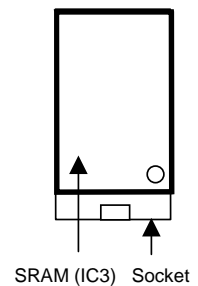
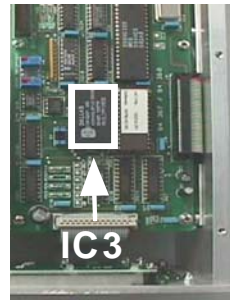

### Power-fail battery

(this is an option which is installed if controller part-no. is 641PM- . 6B . - ....., see chapter ,5 Spare Parts / Retrofit Options' part number.)

When the PFO battery life expires, PFO battery needs to be exchanged. Production date is specified on label on the rear panel of PM controller. Life time of NiCd-battery is specified with 20'000 hours if surrounding temperature is not higher than 30°C . A significant decrease is directly linked with higher temperatures. The following diagram shows the influence on life time at various ambient temperatures.

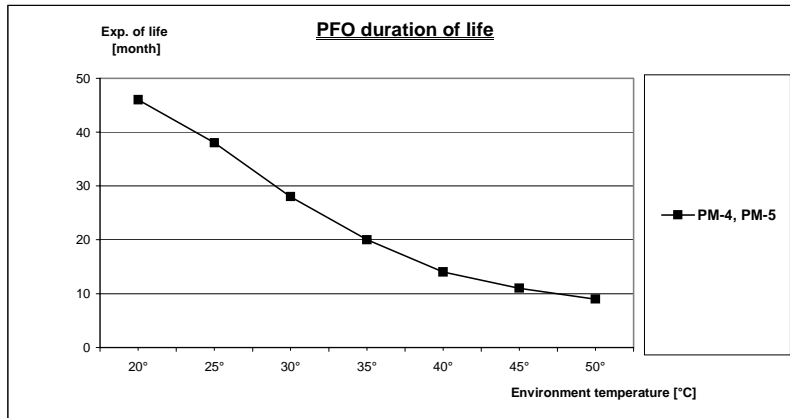

Procedure:

- Turn off power to PM controller, disconnect power cable and wait for 60 seconds
- Disconnect sensor cable, valve cable and interface cable
- Open bottom and top covers
- Disconnect connector J5 of battery pack from the bottom side
- Remove the battery pack from the top side
- Install new battery pack and plug in connector J5 of battery pack
- Reattach covers
- Attach label with new production date on rear panel



## 5 Spare Parts / Retrofit Options

Description	Ordering No.
Preventive maintenance kit for PM controller with power-fail option, consisting of: SRAM, battery pack, label	86705-R1
Preventive maintenance kit for PM controller without power-fail option, consisting of: SRAM, label	86706-R1
Battery pack for power-fail option, for retrofit	67786-R1
LOGIC interface	207806
RS232C interface	75944-R1
Service Box for PM-4	600BS-29NN

## 6 Trouble Shooting

Problem	Recommendation
Front panel: LED's and LCD display inactive	<ul style="list-style-type: none"><li>- Check, if mains switch is on, mains cable is connected, mains supply is on</li><li>- Check fuses at rear panel of PM controller</li></ul>
Control does not respond to keyboard commands	<ul style="list-style-type: none"><li>- Control in REMOTE, switch PM controller to LOCAL</li></ul>
No or weak text on LCD display	<ul style="list-style-type: none"><li>- Adjust brightness; «F1» &amp; «F2» &amp; «↑» key</li></ul>
'PAR:ER' or flashing 'P' displayed	<ul style="list-style-type: none"><li>- New auto learning should be performed</li><li>- If error occurs after new auto learning <u>and</u> power disruption, replace battery powered SRAM memory</li></ul>
'ROM:ER' displayed	<ul style="list-style-type: none"><li>- EPROM defective, to be changed</li></ul>
LED on «CLOSE» key is flashing, valve is closed and does not respond to RS 232 or keyboard commands	<ul style="list-style-type: none"><li>- Logic CLOSE input on RS 232 interface is active</li></ul>
Pressure reading is wrong Negative pressure reading	<ul style="list-style-type: none"><li>- Confirm that sensor setup is correct, press «LEARN» &amp; «ZERO»</li><li>- When base vacuum is reached and pressure reading is off, perform ZERO command</li></ul>
ZERO command does not work	<ul style="list-style-type: none"><li>- Valve is not in open position, OPEN valve and bring chamber to high vacuum</li><li>- ZERO command is disabled, check sensor setup («LEARN» &amp; «ZERO»)</li></ul>
Display not '0' after ZERO command	<ul style="list-style-type: none"><li>- Sensor offset voltage is larger than <math>\pm 1.4V</math></li><li>- System not pumped to base pressure</li></ul>
Pressure control not optimal after LEARN command	<ul style="list-style-type: none"><li>- The PM controller reoptimizes the parameters for each set point, repeat pressure control command after adaption is completed</li><li>- ZERO command was not performed before LEARN command</li><li>- LEARN command was performed with different gas flow, repeat LEARN sequence</li><li>- Make sure sensor range is suited for application (&gt;3% of f.s.)</li><li>- Noise on sensor signal, check sensor voltage, make sure a shielded sensor cable is used</li></ul>
Valve open or in control mode 'E' displayed on front panel	<ul style="list-style-type: none"><li>- Pendulum plate does not reach end position because of mechanical obstruction.</li><li>- Check valve installation (torque on valve flange mounting screws too high, see Installation and Operating Instruction for valve!). Check and clean valve</li></ul>



Problem	Recommendation
LOGIC interface installed: Controller does not respond to logic inputs	<ul style="list-style-type: none"><li>- Switch to «REMOTE»</li><li>- Verify that logic Interface is installed correctly</li><li>- 'LOGIC' is displayed on front panel during start-up.</li></ul>
LOGIC interface installed: Controller does not respond to analog position or pressure setpoint	<ul style="list-style-type: none"><li>- One of the 4 setpoints, OPEN or CLOSE digital inputs are activated</li></ul>
RS232C interface installed: Controller does not respond to RS 232 commands	<ul style="list-style-type: none"><li>- Verify settings of the switch S1 on the RS232C interface are correct</li><li>- Confirm that RS232C interface is installed correctly</li><li>- 'MIXED' is displayed on the LCD display during start-up</li><li>- Confirm that PM controller is in REMOTE</li><li>- Logic inputs on RS232C interface override RS232 commands</li></ul>
RS232C interface installed: Controller responds with error message	<ul style="list-style-type: none"><li>- Wrong command or transmission error, see chapter ,9.3 RS232C Communication'</li></ul>

## 7 Repairs

Contact VAT for repair. Please check first the fabrication No. 641P . - . . . . - . . . . - . . . . ) marked on the rear panel of the PM controller. Your VAT representative will discuss with you how the repair can be carried out best.

## 8 Warranty

Each product sold by VAT Vakuumentile AG (VAT) is warranted to be free from the manufacturing defects that adversely affect the normal functioning thereof during the one-year period immediately following delivery thereof by VAT, provided that the same is properly operated under conditions of normal use and that regular, periodic maintenance and service is performed or replacements made, in accordance with the instructions provided by VAT. The foregoing warranty shall not apply to any product or component that has been repaired or altered by anyone other than an authorized VAT representative or that has been subject to improper installation or abuse, misuse, negligence or accident. VAT shall not be liable for any damage, loss, or expense, whether consequential, special, incidental, direct or otherwise, caused by, arising out of or connected with the manufacture, delivery (including any delay in or failure to deliver), packaging, storage or use of any product sold or delivered by VAT shall fail to conform to the foregoing warranty or to the description thereof contained herein, the purchaser thereof, as its exclusive remedy, shall upon prompt notice to VAT of any such defect or failure and upon the return of the product, part or component in question to VAT at its factory, with transportation charges prepaid, and upon VAT's inspection confirming the existence of any defect inconsistent with said warranty or any such failure, be entitled to have such defect or failure cured at VAT's factory and at no charge therefor, by replacement or repair of said product, as VAT may elect. VAT MAKES NO WARRANTY OR REPRESENTATION OF ANY KIND, EXPRESS OR IMPLIED, (INCLUDING NO WARRANTY OR MERCHANTABILITY), EXCEPT FOR THE FOREGOING WARRANTY AND THE WARRANTY THAT EACH PRODUCT SHALL CONFORM TO THE DESCRIPTION THEREOF CONTAINED HEREIN, and no warranty shall be implied by law.

Furthermore, the «Terms of sale» at the back of the price list are applicable.



## 9 Engineering Information

### 9.1 Wiring of Connectors

#### 9.1.1 Connector for sensor 1 and sensor 2

PIN	Description
1	Connect shield of sensor cable
7	(-) Sensor signal
8	(+) Sensor signal
10	+ 15 VDC, max., $\pm 5\%$ , 1400 mA max. *
12	0 VDC
14	- 15 VDC, max., $\pm 5\%$ , 1400 mA max. *

\*) total current for both sensors is 1400mA

**Mind: Do not connect other Pins than indicated in the table above!**

#### Recommendations:

- Use only **shielded sensor cables**
- Keep cable as short as possible, but locate it away from noise sources
- Use power supply of the PM controller for the sensor
- Mount the sensor, especially capacitance diaphragm gauges, at a place free of mechanical shock and/or vibrations
- Observe recommendations of sensor manufacturer

#### 9.1.2 Connector for mains

PIN	Description
L	Phase (100 - 240 VAC $\pm 10\%$ , 50/60Hz, 150 VA max.)
N	Neutral
	Ground



### 9.1.3 Connector for interface

PM controller may be equipped with a Logic, RS232C or no interface.

#### 9.1.3.1 Logic interface

Connection via 25-pole D-subminiature socket INTERFACE located on the rear of the PM controller. A counter plug is attached to each control unit.

PIN	Function	Description
<b>Digital Inputs</b>		<b>Inputs to PM controller</b>
6	Common (-)	Common for all external inputs. Use relay or optocoupler.
7	Control mode	Contact closed = pressure control mode Contact open = position control mode
14 2 1 4	Set point 1 Set point 2 Set point 3 Set point 4	If no set point is selected, the PM controller uses the analog signal on PIN 24 (if position mode is selected) or PIN 25 (if pressure mode is selected) as set point.  Mind: Do not select set point 3 and set point 4 at the same time (see below).
1, 4	Auto size adjust	This function will be started by connecting PIN 1 and PIN 4 to PIN 6 at the same time for at least 1 second.
3	ZERO	Automatic zero adjustment for pressure sensor. Contact to be closed for 0.5 s min.
19	LEARN	Contact closed = auto learning as long as contact is closed Contact open = auto learning is interrupted
15 17	CLOSE valve OPEN valve	Contact closed = valve closes Contact closed = valve opens <b>Notice:</b> The valve remains closed or open as long as the contact is closed. Close has higher priority than open.
5	DISABLE LOCAL	Contact closed = PM controller is switched into remote mode, key pad LOCAL is disabled as long as contact is closed Contact open = key pad LOCAL enabled, PM control unit remains in remote mode
16	Hold	Contact closed = hold
<b>Digital Outputs</b>		<b>Outputs from PM control unit to host controller</b>
20	Common	Common for Digital Outputs
8	Valve in OPEN position	Contact closed = valve is in open position
9	Valve in CLOSED position	Contact closed = valve is in closed position
21	PM in REMOTE mode	Contact closed = PM controller unit is in REMOTE operation
22	Deviation	Contact closed during zero adjust, learn procedure, in position mode while actual valve position exceeds 0.1 % of position setpoint, in pressure mode while actual pressure exceeds 2 % of pressure setpoint
<b>Analog Signals</b>		
13	Common	Analog ground
24	Position setpoint input	The voltage is proportional to the rotation angle of the rotary feedthrough 10V = 1000 = open, 0V = 0000 = closed but not yet isolated, R <sub>i</sub> > 100kOhm (Use digital input for isolation function)
25	Pressure setpoint input	The voltage is proportional to the pressure set point 10V = FS of pressure range, 0V = 0, R <sub>i</sub> > 100kOhm
11	Position output	The rotation angle of the rotary feedthrough is proportional to the voltage 10V = 1000 = open, 0V = 0000 = closed, 1mA max. (Use digital output for isolation function monitoring)
12	Pressure output	The voltage is proportional to the actual pressure 10V = FS of pressure range, 0V = 0, 1mA max.
10 23	potentiometer supply 1 potentiometer supply 2	Auxiliary voltage +15V, R <sub>i</sub> = 3.9kOhm Auxiliary voltage +15V, R <sub>i</sub> = 3.9kOhm

**Mind: Do not connect other Pins than indicated in the table above!**



## Installation, Operating, and Maintenance Instructions Series 64.1

---



### 9.1.3.2 RS232C interface

PIN	Function	Description
	<b>RS232C</b>	
2	TxD	Transmitted data from the PM control
3	RxD	Received data by the PM control
7	GND	Signal Ground
1	Ground 	Chassis Ground
	<b>Digital Inputs / Outputs</b>	
15	CLOSE VALVE input	Valve will close when contact PIN 15 to 23 is closed
17	OPEN VALVE input	Valve will open when contact PIN 17 to 23 is closed
23	Common for digital input	Use relay or optocoupler
8	OPEN VALVE output	Valve is open when contact between PIN 8 and 10 is closed, 70V / 0.5 A max.
9	CLOSE VALVE output	Valve is closed when contact between PIN 9 and 10 is closed, 70V / 0.5 A max.
10	Common for digital output	70V , 0.5A max.

**Mind: Do not connect other Pins than indicated in the table above!**

**Note:** Logic inputs CLOSE valve and OPEN valve are executed in REMOTE and LOCAL operation. These signals have priority (CLOSE is higher than OPEN) and they are executed immediately.

Local operation:

- The controller remains in OPEN or CLOSE after the logic input is reset.

Remote operation:

- The controller will resume the previous command after the logic input is reset.
- In case a RS232 command is received while a logic input is active this will be accepted by the PM controller and executed after the logic input is reset.

A flashing LED on the «OPEN» or «CLOSE» key indicates that the logic input OPEN valve, resp. CLOSE valve is activated.

## 9.2 RS232C Interface Configuration

### 9.2.1 Options

OPTION:	Default:	RANGE / DESCRIPTION:
- Baud rate:	4800	110 to 19200
- Parity bit:	Even	even, odd, "1", or "0"
- Data length:	7 bits	7 or 8 bits
- Stop bit/s:	1	<b>Note:</b> If 2 stop bits are required, parity bit has to be set to "1" and it will then serve as additional (second) stop bit.
- 2 <sup>nd</sup> acknowledgement (Answer) enabled Yes/No	NO	Immediately after receipt of the command, the PM controller will send an acknowledgement that the command has been received. Please refer to section '9.3 RS232C Communication' for details. If 2 <sup>nd</sup> command acknowledgement is enabled, the PM controller will send a second acknowledgement after the command has been executed. Example: "C:<CR><LF>" <b>command will close valve. The PM controller will reply immediately afterwards with "C:&lt;CR&gt;&lt;LF&gt;".</b> The valve will start to close. If 2 <sup>nd</sup> acknowledgement is enabled, then the PM controller will send in addition "C:<CR><LF>" <b>when the valve is in CLOSED position.</b>
- Logic inputs	-	No function

### 9.2.2 Microswitch configuration

**Note:** Your PM controller may be ordered with a customized factory configuration.

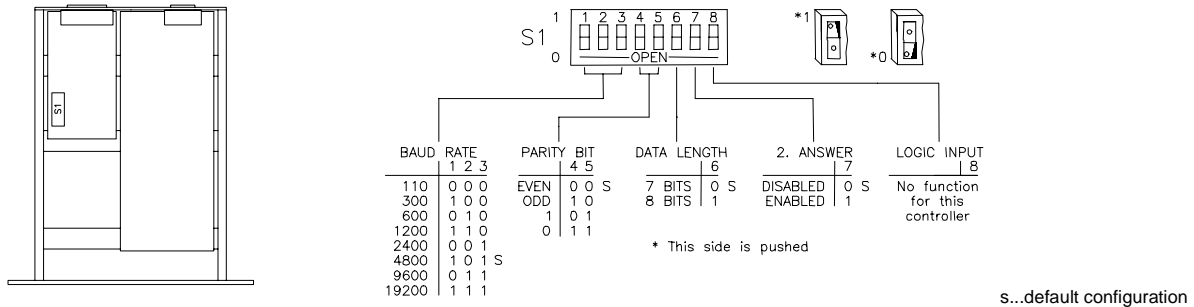

Default setting for 64PM.3I.00: «10100001»

**Change of the configuration:** Switch off mains supply, disconnect mains connector, wait for 60 s, open top cover and set DIL switches to the desired setting.

## 9.3 RS232C Communication

	<p><b>Logic inputs CLOSE and OPEN are executed in REMOTE <u>and</u> LOCAL operation. These signals have priority (CLOSE is higher than OPEN) and they are executed immediately (see chapter ,9.1.3.2 RS232C interface' for details)</b></p>
--	---



### 9.3.1 Control commands

**Note:**

<CR> = Carriage Return (0D hexadecimal); <LF> = Linefeed (0A hexadecimal); \_ = Space (20 hexadecimal)

Control commands starting with 'U:' are accepted in REMOTE and LOCAL mode. All other control commands are accepted only, when the PM controller is in REMOTE mode.

Control commands are acknowledged by one or two acknowledgements:

1st acknowledgement: Confirmation that command has been received, within 40 ms

2nd acknowledgement: If enabled, confirmation that command has been executed

Please refer to chapter '9.2 RS232C Interface Configuration' to select 1 or 2 command acknowledgements.

Description	Commands	Acknowledgements 2nd acknowledgement in parenthesis	Examples / Explanation
Remote Operation	U:01<CR><LF>	U:<CR><LF>	= switch to Remote
Local Operation	U:02<CR><LF>	U:<CR><LF>	= switch to Local
Close valve	C:<CR><LF>	C:<CR><LF> (C:<CR><LF>)	= close
Open valve	O:<CR><LF>	O:<CR><LF> (O:<CR><LF>)	= open
Select valve position in 1/1000 of stroke (0000 = closed, 1000 = open)	R:xxxxx<CR><LF>	R:<CR><LF> (R:<CR><LF>)	R:000428<CR><LF> = 428 * 1/1000 of stroke
Zero adjust Sensor offset adjustment	Z:<CR><LF>	Z:<CR><LF>	Automatic zero adjustment
Learn up to maximum pressure to be learned in 1/1000 of sensor full scale	L:00xxx<CR><LF>	L:<CR><LF>	L:001000<CR><LF> = up to sensor full scale L:000100<CR><LF> = up to 100 * 1/1000 = 10%
Pressure command: 'S.' Standard command xxxx = 0000 to 1000 Pressure in 1/1000 of full scale	S:00xxx<CR><LF>	S:<CR><LF> (S:<CR><LF>)	S:000119<CR><LF> = 119 * 1/1000 of sensor full scale
Select Sensor 1	U:12<CR><LF>	U:<CR><LF>	Default, after power on
Select Sensor 2	U:13<CR><LF>	U:<CR><LF>	
Hold mode Freeze valve position	H:<CR><LF> K:<CR><LF>	H:<CR><LF> K:<CR><LF>	= start hold = change to pressure mode Note: Command can be used in pressure and position mode.
Reduced positioning speed in 1/1000 of maximum speed (remains stored until next speed is given and is set to 1000 after mains is switched off) Function is active for R:	V:xxxxxx<CR><LF>	V:<CR><LF>	V:000200<CR><LF> R:000428<CR><LF> = Actuator speed is 200 * 1/1000 = 20% of maximum speed, while gate is moved to position 428 * 1/1000 = 428
Auto size adjust	J:<CR><LF>	J:<CR><LF>	Automatic adjustment to valve size
Disable Power Failure Option	U:14<CR><LF>	U:<CR><LF>	After power-up, PFO is always enabled.
Enable Power Failure Option	U:15<CR><LF>	U:<CR><LF>	
Interlock front panel keys	U:03<CR><LF>	U:<CR><LF>	= interlock Local/Remote buttons
	U:04<CR><LF>	U:<CR><LF>	= release Local/Remote buttons
Disable LOGIC INPUT	U:16<CR><LF>	U:<CR><LF>	= Disable LOGIC INPUT
Enable LOGIC INPUT	U:17<CR><LF>	U:<CR><LF>	= Enable LOGIC INPUT



### 9.3.2 Inquiry commands

**Note:**

<CR> = Carriage Return (0D hexadecimal); <LF> = Linefeed (0A hexadecimal); \_ = Space (20 hexadecimal)

Inquiry commands are accepted in REMOTE and LOCAL mode. After receipt of an inquiry command, the PM controller sends back the corresponding acknowledgement within a maximum of 40 ms.

Description	Commands	Acknowledgements	Examples / Explanation
<u>Actual valve position</u> in 1/1000 of stroke	A:<CR><LF>	A:xxxxxx<CR><LF>	A:000428<CR><LF> = 428 * 1/1000 of stroke (0 = closed, 1000 = open)
<u>Actual pressure</u> in 1/1000 of sensor full scale	P:<CR><LF>	P:xxxxxx<CR><LF>	P:000119<CR><LF> = 119 * 1/1000 of sensor full scale P: -00004<CR><LF> = -4 * 1/1000 of sensor full scale (-0.4%(sensor offset))
<u>Pressure setpoint value</u>	W:<CR><LF>	W:xxxxxx<CR><LF>	W:000119<CR><LF> = 119 * 1/1000 of sensor full scale
<u>Operating mode</u>	I:<CR><LF>	I:LOCAL<CR><LF> I:REMOTE<CR><LF> I:LOCKED<CR><LF>	= LOCAL mode = REMOTE mode = logic inputs from RS232 are active
<u>Control mode</u>	M:<CR><LF>	M: POS<CR><LF> M: PRESS<CR><LF>	= POSITION MODE = PRESSURE MODE
<u>Self test</u>	T:<CR><LF>	T:___OK<CR><LF> T:PAR-ER<CR><LF> T:ROM-ER<CR><LF>	= memory o.k. = parameter error = EPROM error (see section '6 Trouble Shooting' if «PAR-ER» or «ROM-ER» appears)
<u>Sensor zero offset</u> in 1/1000 of sensor full scale	z:<CR><LF>	z:xxxxxx<CR><LF>	z:000015<CR><LF> = 15 * 1/1000 of sensor full scale
<u>Valve cycle counter</u>	c:<CR><LF>	c:xxxxxxxxxx<CR><LF>	c:0000125013<CR><LF> = 125'013 cycles
	n:<CR><LF>	n:<CR><LF>	= set counter to zero
<u>Software version</u>	i:01<CR><LF>	i:01xxxxxxxx<CR><LF>	i:0164PM3100<CR><LF> = software version 64PM.31.00
<u>Read current sensor 1 setup</u>	i:02<CR><LF>	i:02sabcdef<CR><LF>	Current sensor 1 setup; for abcdef refer to setup commands:
<u>Read current sensor 2 setup</u>	i:03<CR><LF>	i:03sabcdef<CR><LF>	Current sensor 2 setup; for abcdef refer to setup commands:
<u>Position error</u>	p:<CR><LF>	p:___OK<CR><LF> p:POS-ER <CR><LF>	= position o.k. = plate position error
	f:<CR><LF>	f:<CR><LF>	= reset error flag
<u>Valve position</u>	i:05<CR><LF>	i:05V1:aV2:b<CR><LF>	a = 0 (valve 1 open) a = C (valve 1 closed) a = N (valve 1 in intermediate pos.) b = - (not connected)
<u>Upload of learned data</u>	u:mmm<CR><LF>	u:mmmdddddddddd<CR><LF>	mmm = index 000-082 to up-/download complete data all indices have to be used ddd.. = data in hexadecimal format (0...9, A...F)
<u>Download of learned data</u>	d:mmmdddddddddd<CR><LF>	d:mmm<CR><LF>	

### 9.3.3 Sensor setup command

**Note:**

<CR> = Carriage Return (0D hexadecimal); <LF> = Linefeed (0A hexadecimal); \_ = Space (20 hexadecimal)

Sensor setup commands are accepted only, when the PM controller is in REMOTE mode.

Description	Commands	Acknowledgements	Examples / Explanation
<u>Sensor Setup</u>	<b>s:abcdef&lt;CR&gt;&lt;LF&gt;</b>	<b>s:&lt;CR&gt;&lt;LF&gt;</b>	s:2332010<CR><LF>
x = Sensor nr.	1 = sensor 1 2 = sensor 2		2 = sensor 2
a = Voltage Range	0 = 0 - 1 V, 1 = 0 - 2 V, 2 = 0 - 5 V, 3 = 0 - 10 V		3 = 0 - 10 V input signal
b = Display Range	0 = 0 - 1.000, 1 = 0 - 2.000, 2 = 0 - 5.000, 3 = 0 - 10.00, 4 = 0 - 20.00 5 = 0 - 50.00, 6 = 0 - 100.0, 7 = 0 - 200.0, 8 = 0 - 500.0, 9 = 0 - 1000 A = 0 - 2000, B = 0 - 5000, C = 0 - 2.500, D = 0 - 25.00, E = 0 - 250.0 F = 0 - 2500		3 = 0 - 10.00 full scale
c = Display Unit	0 = mbar, 1 = µbar, 2 = Torr, 3 = mTorr, 4 = Pa, 5 = kPa, 6 = V, 7 = % 8 = 0001-1000, 9 = none, A = Position Mode only		2 = pressure display in Torr
d = Gain Factor	0 = 1.00, 1 = 1.33, 2 = 1.78, 3 = 2.37, 4 = 3.16, 5 = 4.22, 6 = 5.62 7 = 7.50, 8 = 0.1, 9 = 0.13, A = 0.18, B = 0.23, C = 0.32, D = 0.42, E = 0.56 F = 0.75		0 = Gain factor 1.00
e = Sensor Type	0 = mbar / Pa, 1 = Torr		1 = Torr sensor
f = Zero Adjust	0 = enable, 1 = disable		Zero adjust enable

### 9.3.4 Error messages

Error messages	Description
<b>E:000001&lt;CR&gt;&lt;LF&gt;</b>	Parity error
<b>E:000002&lt;CR&gt;&lt;LF&gt;</b>	<CR> or <LF> is missing
<b>E:000003&lt;CR&gt;&lt;LF&gt;</b>	«:» is missing
<b>E:000004&lt;CR&gt;&lt;LF&gt;</b>	Wrong letter code
<b>E:000005&lt;CR&gt;&lt;LF&gt;</b>	Numerical value not given in 6 digits
<b>E:000006&lt;CR&gt;&lt;LF&gt;</b>	Numerical value larger 1000
<b>E:000007&lt;CR&gt;&lt;LF&gt;</b>	PRESSURE MODE, ZERO or LEARN have been selected with no sensor connected (display format set for no sensor)
<b>E:000008&lt;CR&gt;&lt;LF&gt;</b>	Instruction given in operating mode LOCAL
<b>E:000009&lt;CR&gt;&lt;LF&gt;</b>	RS232 commands <b>Z</b> , <b>L:XXXXXX</b> or <b>J</b> : given while a logic input is activated
<b>E:000101&lt;CR&gt;&lt;LF&gt;</b>	<u>Error with LEARN</u> Pressure at closed valve is smaller than 5% of the sensor full scale
<b>E:000200&lt;CR&gt;&lt;LF&gt;</b>	<u>Error with ZERO</u> - valve is not in open position - PM controller is switched in control mode PRESSURE MODE - function ZERO blocked (= DISABLED)



## 9.4 User Information and Recommendations

### 9.4.1 Operation sequence of PM controller

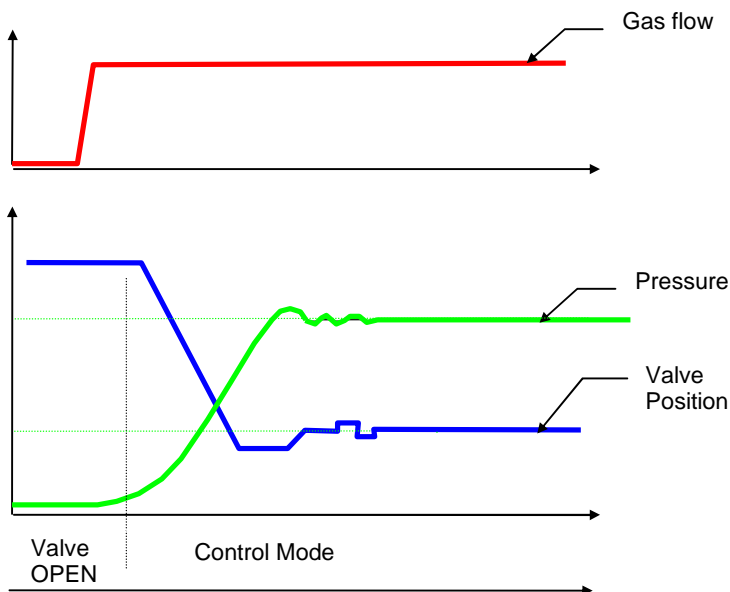

#### Initialization

Prior to pressure control the setup sequence needs to be performed. Please refer to chapter ,2.3 PM Configuration (setup sequence)‘

#### Pressure Control Sequence in LOCAL mode or with ‘S:’ Command

Pressure control starts after «PRESSURE MODE» and a «SET POINT» is selected or after a pressure control command is sent to the PM controller.

### 9.4.2 How to optimize sensor signal resolution

Full scale signal of the sensor is converted by a 12bit AD converter. The resolution depends therefore on the Voltage Range.

**Example:** Sensor: 1 Torr full scale, 0 to 10 VDC output;  
 Required pressure range: 0 to 120 mT

Standard sensor setup on PM: Voltage Range: 0-10V, Display Range: 1, Display Unit: Torr  
 → Resolution of PM controller: 1Torr \* 0.03% = 0.3mT

Recommended for sensor setup: Voltage Range: 0-2V, Display Range: 0-200, Display Unit: mTorr  
 → Resolution of PM controller: 200mTorr \* 0.03% = 0.06mT